



Pushing Performance



People | Power | Partnership

# HARTING

## User's Guide Termination Technologies

---

## **HARTING User's Guide Termination Technologies**

All brand and product names are trademarks or registered trademarks of the owner concerned.

2<sup>nd</sup> Edition 2016, revised 02/16

© HARTING Electric GmbH & Co. KG, HARTING Electronics GmbH & Co. KG

Title: HARTING Technology Group, Espelkamp  
Other figures – sources: HARTING Electric GmbH & Co. KG  
HARTING Electronics GmbH & Co. KG

HARTING Electric GmbH & Co. KG | HARTING Electronics GmbH & Co. KG  
Wilhelm-Harting-Str. 1 | Marienwerder Str. 3  
32339 Espelkamp – Germany | 32339 Espelkamp – Germany  
Phone +49 5772 47-0 | Phone +49 5772 4797200

Subject to alterations without notice

Printed in the Federal Republic of Germany

---

## I. Preface

The right termination technique plays a crucial role in connecting devices, machinery and equipment reliably and efficiently. Innovative, quick-release connections ensure long-lasting flexibility and facilitate future-oriented modular structures. However, choosing the connector requires detailed knowledge and practical experience. Which connector solution is right for my application? This little manual has been put together by connector experts from HARTING Electric, HARTING Electronics and HARTING Germany to help you answer this question.

The manual should help you to select components as well as install or assemble HARTING connectors and contacts. It contains instructions on proper and professional execution of terminations and provides the necessary criteria to check whether an interface is designed according to standards. The manual is divided into termination techniques, so you can find the right solution for your application quickly and easily. *Italicised* terms are explained in the glossary.

The HARTING manual on termination techniques first appeared in 2008 under the title "About termination technologies for connectors". This edition has been revised extensively. The depth of revision varies from one chapter to the next and depends on the technical innovations and changes to standards in the fields concerned.

Andreas Wedel  
Head of Technical  
Competence Center TCC  
HARTING Electric GmbH & Co. KG

Heinz-Günter Vieker  
Head of Tech. Application  
Support  
HARTING Deutschland GmbH

Hartmuth Schmidt  
Director of GPM  
HARTING Electronics GmbH

### General notice:

HARTING reserves the right to make construction changes in response to manufacturing requirements, improved quality or advances in the design. This product information describes the components but should not be considered as a guarantee of certain properties.

## Table of Contents

<b>I. Preface .....</b>	<b>1</b>
<b>II. Protection against electric shock .....</b>	<b>9</b>
1. Introduction .....	10
2. PE termination for connectors .....	11
3. Han-Modular® .....	12
4. Han® 7 D .....	15
5. Han-Snap® .....	15
6. Termination of PE wires .....	17
<b>III. Screw termination technology .....</b>	<b>19</b>
1. Introduction .....	20
2. Screw terminal types .....	20
3. Screw termination with/without wire protection .....	22
4. Advantages .....	22
5. Han® connector with screw terminal technology .....	23
6. Screw terminals for high-current contacts .....	24
<b>IV. Axial screw termination technology .....</b>	<b>27</b>
1. Overview of the axial screw termination .....	28
2. Advantages .....	28
3. Application areas .....	29
4. Normative requirements: wire gauges .....	29
5. Stripping lengths, tightening torques, relevant series .....	31
6. Assembly .....	36
6.1 Tools .....	36
6.2 Notes on using the assembly tools .....	37
6.3 Assembly notes .....	38
6.4 Strain relief .....	39
6.5 Maintenance of axial screw connections .....	40

6.6 Correct positioning of the cable.....	40
7. Assembly of cables with large outer diameters.....	41
<b>V. Crimp termination.....</b>	<b>45</b>
1. Introduction .....	46
2. Features of the crimp contacts .....	46
3. Advantages of the crimp termination technique .....	47
4. Standards and guidelines for the crimping technology .....	48
4.1 Standard DIN EN 60 352-2 .....	48
4.2 Test for the wire pull-out forces .....	49
4.3 Assessment with the help of cross-sections .....	51
4.4 Measuring the crimp heights (open barrel crimping, B-form crimping) ..	53
4.5 Visual inspection – position of the wire in the crimp contact.....	54
5. Overview of crimp tool (closed barrel crimping).....	56
5.1 Manual crimp tools/machines according to cross-section .....	56
5.2 HARTING Crimp tools/die and application areas .....	59
6. Crimp tools for DIN 41 612/interface contacts (open crimping) .....	67
7. Overview of stripping lengths and insulation diameters.....	70
8. Overview of crimping tools.....	71
8.1 Crimping machines for turned contacts.....	71
8.2 Crimping machines for reel-packaging contacts .....	75
9. Operating instructions for HARTING crimp tools.....	76
9.1 Four-indent crimp tool 09 99 000 0888.....	76
9.2 HARTING Crimping tool 09 99 000 0110.....	84
9.3 Operating instructions for service crimp tool 09 99 000 0021.....	85
9.4 Operating instructions for crimp tool 09 99 000 0303 .....	89
9.5 Operating instructions for crimp tool 09 99 000 0377 .....	91
9.6 Crimp tool for D-Sub reel-packaged contacts 09 99 000 0169 .....	94
9.7 HARTING crimp tool 09 99 000 0620 for stamped contacts BC and FC according to DIN 41 612.....	96
9.8 HARTING service crimp tool 09 99 000 0191 for FC individual contacts .....	98
10. Assembly and disassembly instructions .....	100
10.1 Assembly of contacts.....	100
10.2 Removal of contacts .....	101

<b>VI. Cage-clamp termination.....</b>	<b>105</b>
1. Introduction .....	106
2. Features.....	107
2.1 Cage-clamp termination technology: general information.....	107
2.2 Cage-clamp combined with press termination technique (Han® ES Press).....	107
3. Cage-clamp terminals in HARTING products.....	108
4. Assembling the cable-clamp terminals.....	109
4.1 Standard cage-clamp contacts .....	109
4.2 Han® ES Press.....	111
4.3 Using ferrules.....	113
4.4 Possible assembly errors .....	113
5. Standards and guidelines.....	114
<b>VII. Han-Quick Lock®.....</b>	<b>115</b>
1. Radial cage-clamp.....	116
2. Cage-clamp terminal and Han-Quick Lock® .....	116
3. Useable cable types.....	117
4. Advantages .....	118
5. Application areas .....	118
6. Normative requirements .....	119
7. Technical details .....	119
7.1 Stripping lengths, cable cross-sections.....	119
7.2 Micrographs.....	120
8. Series with Han-Quick Lock® .....	121
9. Suitable tools.....	123
10. Assembly instructions.....	123
10.1 Assembly .....	123
10.2 Removal.....	124

<b>VIII. Solder termination technology</b> .....	<b>125</b>
1. Introduction .....	126
2. Soldering method.....	127
2.1 Wave soldering.....	127
2.2 Reflow soldering .....	128
3. Soldering bath temperatures for wave soldering.....	129
4. Solder .....	129
5. Soldering profiles.....	130
6. HARTING SMC/SMT .....	131
7. Standards .....	136
8. HARTING connector product range for soldering/SMC/SMT .....	139
<b>IX. Wire wrap termination</b> .....	<b>141</b>
1. Introduction .....	142
2. Wrap types.....	143
3. Tools for the wire wrap technique .....	144
<b>X. Insulation displacement termination technique</b> .....	<b>145</b>
1. Introduction .....	146
1.1 Overview of the insulation displacement connection.....	146
1.2 Standards .....	147
1.3 Industrial connectors .....	147
2. Assembly instructions.....	148
2.1 Assembly instructions for Han 3A with HARAX® termination technique.....	148
2.2 Assembly instructions for unshielded HARAX® M8/M12 .....	149
2.3 Assembly instructions for shielded HARAX® M12 .....	150
2.4 Assembly instructions for HARAX® Pg 13.5/M20 panel feed through.....	151
3. Interface connector .....	152
3.1 D-Sub standard.....	152
3.2 SEK .....	153
3.3 DIN 41 612 connectors .....	155

3.4	Tools for interface and DIN 41 612 connectors .....	155
3.5	Ethernet interfaces .....	158
3.6	Assembly instructions for Ha-VIS preLink® RJ45 connector.....	173
4.	Piercing termination technique .....	174
4.1	Piercing termination overview.....	174
4.2	Assembly instructions for HARTING RJ Industrial® Gigalink Cat. 6 <sub>A</sub> IP20 .....	175
4.3	Assembly instructions for HARTING RJ Industrial® 10G IP65 / 67.....	179
<b>XI.</b>	<b>Press-in technology .....</b>	<b>183</b>
1.	Introduction .....	184
2.	Definition of press-in technology .....	184
3.	Recommended hole layout on the circuit board.....	185
4.	Press-in tools .....	190
5.	Information on hand-lever and pneumatic presses .....	192
6.	Overview of HARTING connectors with press-in technology .....	194
7.	Requirements for press-in technology.....	195
8.	HARTING presses.....	195
9.	Conclusion .....	197
<b>XII.</b>	<b>Fibre optic termination .....</b>	<b>199</b>
1.	Introduction .....	200
2.	Planning of optical transmission systems .....	201
2.1	Influencing factors .....	201
2.2	Calculation examples .....	203
3.	Assembly of fibre optic connectors.....	205
3.1	F-SMA connector for 1 mm POF with 2.2 mm cable sheath .....	205
3.2	F-SMA connectors for 1 mm POF with 3.6 mm cable sheath.....	207
3.3	F-SMA connectors for 1 mm POF with 6 mm cable sheath.....	209
3.4	Quick-assembly connectors for 1 mm POF with 2.2 mm cable sheath.....	211
3.5	FH-ST connectors for 1 mm POF with 2.2 mm cable sheath.....	212
3.6	FO cable end sleeve for 1 mm POF with 2.2 mm cable sheath .....	214
3.7	F-TNC connectors (female) .....	216
3.8	F-TNC connector (male).....	218



3.9 F-ST connectors for glas fibre .....	220
3.10 SC contacts for glass fibre.....	222
3.11 LC contact for GI fibre and single mode fibres.....	224
4. FO contacts .....	226
4.1 FO contacts for Han D® and Han DD® contact inserts .....	226
4.2 FO contacts for Han E® inserts .....	228
4.3 FO contacts for 1 mm POF in Han-Modular®.....	230
4.4 FO contacts for GI fibre in Han-Modular®.....	232
4.5 Han-Brid® FO contacts.....	234
5. HARTING four-indent crimp tool operating instructions for 1 mm POF contacts .....	235
6. Tool kit .....	238
6.1 POF assembly kit with optical measuring devices.....	238
6.2 FO measuring device kit .....	240
6.3 GI-fibre assembly kit .....	241
7. Overview of assembly .....	244
<b>XIII. Attachment .....</b>	<b>249</b>
1. Glossary.....	250
2. Overview of standards .....	252



## Notes

I

A large rectangular area filled with alternating horizontal stripes of yellow and light gray, providing a template for writing notes.

---

## II. Protection against electric shock

### Contents

1. Introduction .....	10
2. PE termination for connectors .....	11
3. Han-Modular® .....	12
4. Han® 7 D.....	15
5. Han-Snap® .....	15
6. Termination of PE wires .....	17

## 1. Introduction

A protective earth is a conductor that provides safety. The abbreviation for protective earth is PE. The function of the protective earth in electrical systems is to protect people and animals from dangerous shock hazard voltage and electric shock in case of a fault (e.g. failure of the insulation for the housing).

II

A protective earth is frequently routed in electric systems and cables. This is colloquially known as protective earth wire, protective earth, earth or earth connection.

The protective earth wire is attached so that an electrical connection between the outer metallic housings of electrical equipment and the earth is established.

If, in case of a fault, the electric supply voltage is routed to touchable conductive parts of electrical equipment, it must be ensured that the current runs through the protective earth so that the electrical equipment with the fault is isolated from the electrical voltage supply within a short time. Here, depending on the application, disconnection times between 0.1 and 5 seconds must be undershot. Disconnection occurs by an earth leakage circuit breaker or by overcurrent protection devices in case of correlating resistances in the wires and the earth connection.

A protective earth must be identifiable with the colour combination green/yellow. This colour combination can only be used for protective earth wires.

The respective equipment manufacturer (installer) or plant operator is always responsible for proper installation of the protective equipment in accordance with the applicable VDE regulations.

## 2. PE termination for connectors

To protect against electric shock, certain measures must be taken the essence of which are defined in the following standards/regulations:

- DIN EN 60 204-1
- DIN VDE 0100-410
- DIN EN 61 984

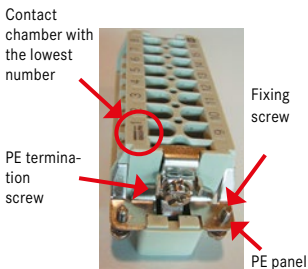
### Note:

*The equipment manufacturer (installer) is fundamentally responsible for the proper, safe operation of the protective earth of an electrical installation!*

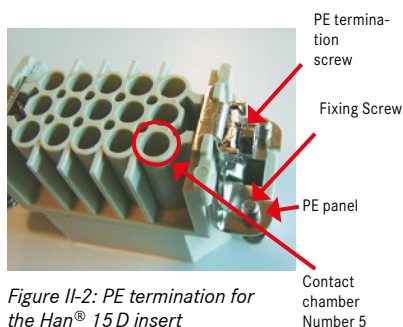
HARTING inserts are designed for terminating the PE. With the standard inserts (Han D<sup>®</sup>, Han DD<sup>®</sup>, Han E<sup>®</sup>, Han<sup>®</sup> EE, Han-Com<sup>®</sup>), termination is always done using a PE screw. The PE screw is located in the PE panel that is mounted at both ends of the contact insert. The fixing screws for assembly in the housing are the conductive connection between PE and the housing so that the housing is earthed.

The PE screw is mounted on the side where the contact chamber with the lowest number is (see Figure II-1, below). This step is specified in DIN EN175 301-801. This specification refers exclusively to the Han D<sup>®</sup> connector series, nevertheless all other non-standardized series such as Han<sup>®</sup> E, Han<sup>®</sup> EE, Han<sup>®</sup> EEE and Han<sup>®</sup> DD are oriented to this specification. It should be noted that the PE screw on the Han<sup>®</sup> 15D and Han<sup>®</sup> 25D is not located on the side with the lowest contact number (see Figure II-2). This exception is also regulated by DIN EN 175 301-801.

The inserts are equipped with two *PE panels*. The *PE panels* each contain two M3 fixing screws for assembly in the housing. They ensure the conductive connection between PE and housing. There is a thread in both *PE panels*



*Figure II-1: PE termination for the Han<sup>®</sup> 16E insert*



*Figure II-2: PE termination for the Han<sup>®</sup> 15D insert*

for screwing in the PE clamping screw. These enable assembly of the shield frames and clamps.

**Note:**

*With unassembled inserts, there is no conductive connection of PE panels with each other. This connection is made only after assembly of the insert in the housing.*

*Bring the PE screw back into the original position (factory setting), if it has been unscrewed completely!*

II

The following subchapters describe the processing of the PE in different HARTING products.

### 3. Han-Modular®

The modules of the Han-Modular® series are fitted in the *hinged frame*. Four fixing screws are used for assembling the hinged frame to the housing. There are two terminations for the protective earth: wire gauges of 4 - 6 mm<sup>2</sup> can be used on the power side (specified tightening torque: 1.2 Nm). For *stranded wires* with wire gauge 10 mm<sup>2</sup>, the termination is only permitted if a wire ferrule is used, for example, with HARTING ferrule pliers 09 99 000 0374. On the control side, *wire gauges* from 1.0 to 2.5 mm<sup>2</sup> are possible, the specified tightening torque is 0.5 Nm (Figure II-3). A *wire ferrule* must be crimped on stranded and fine *stranded wires*.



Figure II-3: Hinged frame - termination sides

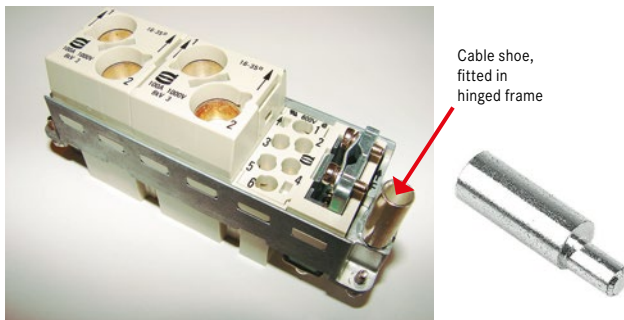


Figure II-4: Cable shoe termination to hinged frame

When using cable shoes, large wire gauges can be processed. HARTING has cable shoes for *wire cross-sections* of 16 mm<sup>2</sup> and 25 mm<sup>2</sup>. Crimp the cable shoes with a crimping tool (e.g. K25 made by Klauke). The process and the result comply with DIN 46 230; the standard that regulates crimping with pressing tools for non-insulated cable connections. You must then connect the cable shoe to the power side of the *hinged frame*.

**Note:**

*The use of cable shoes is only possible in bulkhead mounted housings and hoods that are tall sized.*

*For hoods with side entry, you must place the cable shoe on the opposite side of the cable entry!*

For terminating the PE wires with even larger *wire gauges*, HARTING has developed the PE module (single module) and the 200 A PE double module. These modules allow the processing of *wire gauges* of 10 mm<sup>2</sup> - 70 mm<sup>2</sup>. They are designed so that the housing is connected conductively to the PE via the hinged frame.



Figure II-5: 200 A PE module with crimp termination

The Han-Modular® PE module can be easily fitted in the hinged frame and provides a safe electrical connection between the PE contact, hinged frame and housing. The PE protective earth is leading and complies with IEC 61984.

In order to meet different requirements, the module comes in two different variants - with crimp and axial screw termination. Thanks to its quick and reproducible field wireability, the crimping technology is ideal for transportation applications, for example. Existing crimping tools can still be used, as the crimping zones in the PE module and power contacts are identical. The PE module with axial screw termination has the advantage that an expensive special tool is not required: A hexagonal tightening torque wrench is sufficient. Mechanical engineering is the preferred application area for the variant with axial screw termination technology.

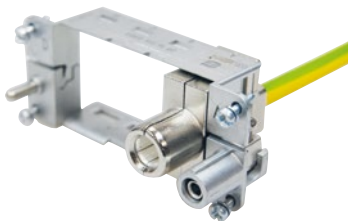


Figure II-6: PE module, fitted in the hinged frame

Table II-1: PE termination possibilities

Cross-section / wire gauge		Termination point	Termination type	Remarks
mm <sup>2</sup>	AWG			
1 - 2.5	18 - 14	Hinged frame, control side	Screw	Use of ferrules that must be crimped before termination using ferrule pliers
4 - 6	12 - 10	Hinged frame, power side	Screw	
10	8	Hinged frame, power side	Screw	
16	6	Cable shoe, hinged frame, power side	Crimp, Screw	Only for hood, tall size and bulkhead-mounted housing; Crimping with crimping pliers, K25 made by Klauke
25	4	Cable shoe, hinged frame, power side	Crimp, Screw	
10 - 35	8 - 2	PE module	Crimp, Axial screw termination	
25 - 70	4 - 00	200 A PE module	Axial screw termination	



## 4. Han® 7D

The inserts from the Han® 7D series are designed for rated voltages up to 250 V and rated currents up to 10 A. The use has seven power contacts and a PE contact. For this application, however, it is inherent in the design that after assembly in the housing, there is no conductive connection between PE and the housing. According to EN 61 984, however, for voltages greater than 50 V AC or 120 V DC, a connection between metallic housings and protective earth is required if the housing is not additionally insulated.



Figure II-7: Han® 7D inserts

In order to nonetheless remain in compliance with standards, the insert is intended only for a plastic housing with size 3 A. The design does not allow for assembly in metal housings. Therefore, in case of a fault, the user is protected against touching any possibly live parts.

## 5. Han-Snap®

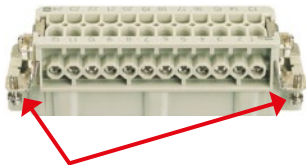
The holders for the Han Snap® series simplify the use of connectors in the electrical cabinet. Components made of plastic are used for areas of the housing that protect the inserts from external influences (this task is performed by the electrical cabinet) and for locking the top and bottom of the connector when plugged in. The parts are designed so that the connectors latch securely. With Han-Snap®, connectors can be used as panel feed throughs, as a “floating connection” or for snapping onto DIN rails.

Because Han-Snap® is made of plastic, pay particular attention to correct positioning when terminating the protective earth. Unlike metal housings, with Han-Snap® there is no conductive connection between the two PE panels of an insert.

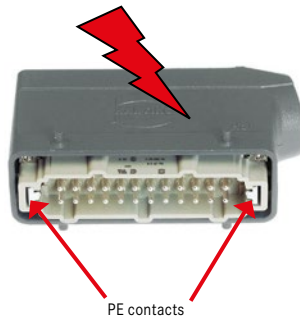
HARTING inserts are equipped with a PE screw that has a defined position. If the PE is correctly terminated, this ensures that there is a conductive PE connection between upper and lower sections.

If you screw the PE screw into the wrong side of the insert, the PE connection at this point is interrupted even when plugged in, because there is no conductive connection between the PE panels. Figures II-8 to II-10 clarify the facts.

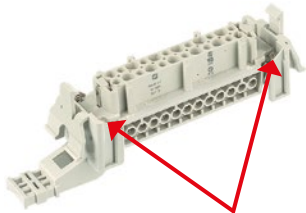
II



*Figure II-8: Unmounted insert:  
The PE panels are not electrically  
connected to each other  
(see arrows)*



*Figure II-9: Insert in the housing:  
There is a conductive connection  
between the PE panels via the  
housing*



*Figure II-10: Insert with Han-Snap®:  
The PE panels are not electrically  
connected to each other  
(see arrows)*

## 6. Termination of PE wires

The cross-section of the PE depends on the nominal cross-section of the current-carrying wires. The minimum cross-section of the protective earth is defined in EN 61 984, Table 1. Table II-2 shows the content of the table in the standard.

Table II-2: Extract from EN 61 984

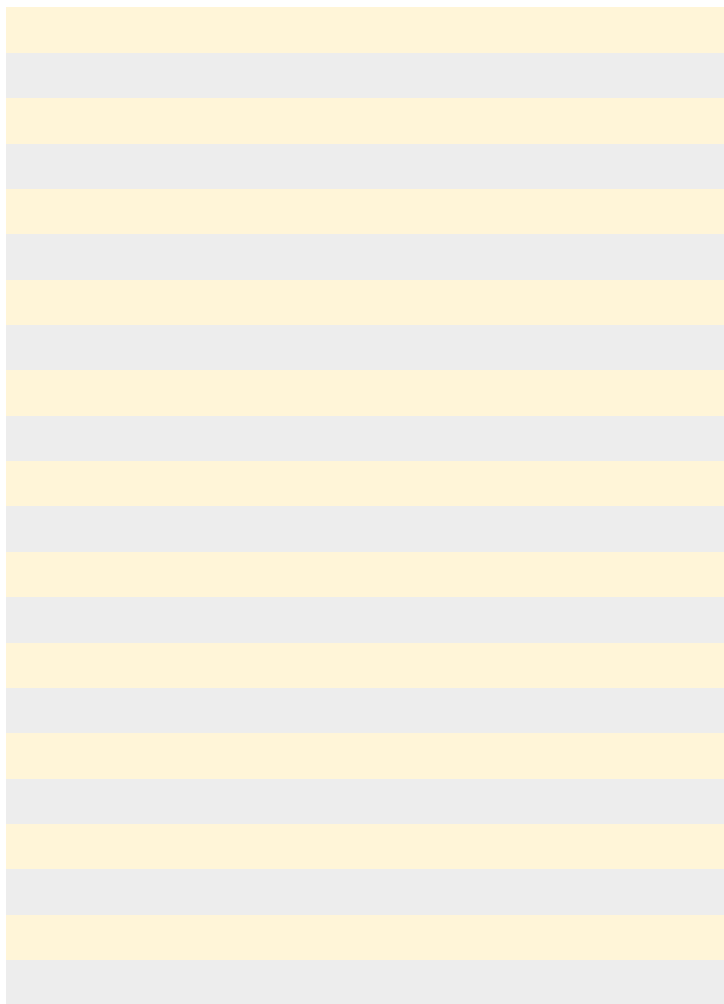
Nominal cross-section of the current-carrying wire mm <sup>2</sup>	Minimum cross-section* of the protective earth and of touchable metal parts or covers that are not used as such mm <sup>2</sup>	Minimum cross-section* of the connection between the protective earth and touchable metal parts or covers that are not used as such mm <sup>2</sup>
Up to 1.5	According to the nominal cross-section of the current-carrying wire	
2.5	2.5	1.5
4	4	2.5
6	6	4
10	10	10
16, 25, 35	16	16

\* Relating to the same material as the current-carrying wire

When terminating PE wires, a distinction is made between direct and indirect termination via cable shoes. With a direct termination, the size of the PE screw must be considered. So the maximum possible cross-section for M4 is 4 mm<sup>2</sup> and for M5 it is 6 mm<sup>2</sup>. When termination is with cable shoes, the data in Table II-2 apply.

## Notes

II



---

## III. Screw termination technology

### Table of Contents

1. Introduction .....	20
2. Screw terminal types .....	20
3. Screw termination with/without wire protection .....	22
4. Advantages .....	22
5. Han® connector with screw terminal technology .....	23
6. Screw terminations for high-current contacts.....	24

## 1. Introduction

In electrical engineering, a terminal is used to connect two electrical conductors. It provides a detachable connection for wires, conductors and cables. A mechanical screw or spring is used to secure the connected wire in the conductive chamber. The Han® E screw insert, shown below, is a classic example of screw termination technology within the Han® product portfolio.



Figure III-1: Han® 24 E insert with screw termination

The screw terminal is the oldest type of connection in the electrical industry. It is still widely used in the field because it provides a versatile, robust and safe electrical supply on-site.

## 2. Screw terminal types

HARTING uses two types of screw terminal:

- Classic screw terminal
- Axial screw terminal

The screw terminal can be operated using a conventional screwdriver. The operating principle corresponds to that of the well-known terminal block. The screw is normally located next to the connection-side contact opening.

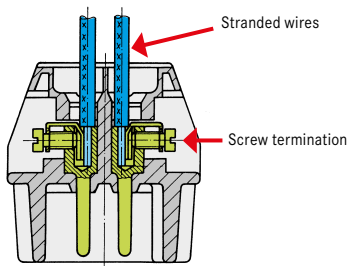


Figure III-2: Schematic view of a connector using screw terminals

For establishing an axial screw contact, a hex (Allen) key is used from the side to turn the tapered screw located in the contact. The tapered screw presses the wire strands evenly against the contact wall (Figure III-3).

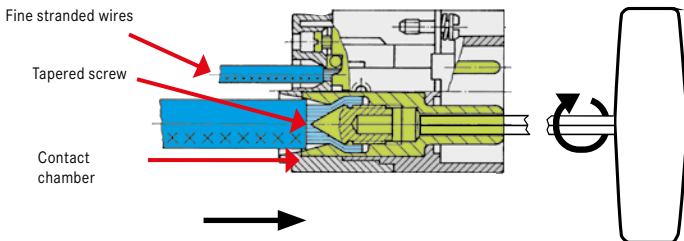


Figure III-3: Schematic view of a standard axial screw contact

DIN EN 60 999 “Connecting Materials” defines and regulates these detachable connections. The standard is used as the basis for HARTING’s screw and axial termination technology.

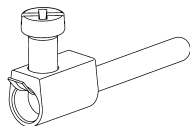
The pull-out force is the main factor for determining the quality of a screw terminal. The pull-out force depends on the cross-section of the wire being connected, as defined in the following standards:

- DIN EN 60 999-1: pull-out forces for wires with cross-sections up to 35 mm<sup>2</sup>
- DIN EN 60 999-2: pull-out forces for wires with cross-sections from 35 – 300 mm<sup>2</sup>

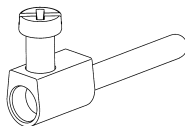
For both types of terminating connections, no special tools or installation training for personnel are required.

### 3. Screw termination with/without wire protection

Screw terminals use a screw connection with or without wire protection. What is the task of this wire protection mechanism? The wire protection consists of a metal tongue; a screw terminal is used to press down on the wire (refer to Figure III-4). This prevents the wire strands from shearing off during the installation. Aside from stripping, the wire ends require no preparation.



*Figure III-4: Screw terminal with wire protection*



*Figure III-5: Screw terminal without wire protection*

There is no metal tongue when the screw terminal does not have the wire protection mechanism (refer to Figure III-5). So, for flexible stranded wires, wire ferrules must be attached to the wire ends. Rigid (solid) wires, when stripped to the proper length, can be used in both variants without any further processing.

### 4. Advantages

- + Easy handling
- + No special tools needed
- + Large cross-section range



## 5. Han® connector with screw terminal technology

HARTING delivers the contact inserts listed below with screw termination technology:

Table III-1: An overview of HARTING contact inserts using screw terminals

Series	Remarks
Han E® Han® HsB Han Hv E® Han® K 6/12 Han A® Han E® screw module (Han-Modular®)	With wire protection
Han® K 4/0 Han® K 4/2 Han® K 4/8 Han A®	Without wire protection

Another issue is the tightening torque of the screw, which is dependent on the size of the screw. The relevant requirements are specified in DIN EN 60 999. Table III-3 lists the tightening torques. The size of the corresponding screwdriver blade must also be taken into account.

Table III-2: Tightening and testing torques for screw terminals

Cross-section (mm <sup>2</sup> )	1.5	2.5	4	6	10	16
Screw thread	M3	M3	M3.5	M4	M4	M6
Test tightening torque (Nm)	0.5	0.5	0.8	1.2	1.2	1.2*
Min. pull-out force for stranded wire (N)	40	50	60	80	90	100

\* For screws without heads

Table III-3: An overview of tightening torques and recommended screwdriver blade sizes

Screw size	Connector type	Tightening torque (Nm)	Recommended screwdriver blade
M3	Screw terminations Han <sup>®</sup> 3A , 4A, Q 5/0	0,25	0.4 x 2.5
M3	Screw terminations Han <sup>®</sup> 10A - 32A	0,50	0.5 x 3.5 or +/- size 1
M3	Screw terminations Han E <sup>®</sup> , Han Hv E <sup>®</sup> , Han E <sup>®</sup> screw module Fastening screws (all sizes) Guide pins & sockets	0,50	0.5 x 3.5 or +/- size 1 + 2
M4	PE terminals Han A <sup>®</sup> , Han E <sup>®</sup> , Han D <sup>®</sup> , Han DD <sup>®</sup> PE terminals K (8/24)	1,20	0.5 x 3.5 or +/- size 1 + 2
M4	Screw terminations Han <sup>®</sup> HsB	1,20	0.8 x 4.5
M5	PE terminals Han <sup>®</sup> HsB Han <sup>®</sup> HsC (K 12/2), K 4/X, K 6/12	2	0.8 x 4.5 1.2 x 8

## 6. Screw terminals for high-current contacts

For high-current contacts, in addition to axial screw and crimp technology, screw terminals can also be used together with cable shoes: variants are available for the Han<sup>®</sup> HC Modular 350 contacts (for cross-sections up to 120 mm<sup>2</sup>) and the Han<sup>®</sup> HC Modular 650 contacts (for cross-sections up to 240 mm<sup>2</sup>). On the termination side, the sets consist of a washer, retention clip and hex screw (M10 for the HC 350 and M12 for the HC 650).

A cable shoe must be crimped on the stripped wire before the assembly. During the assembly, make sure that the components are put together in the correct order (refer to Figure III-6, right).

- ① Hex screw
- ② Retention clip
- ③ Washer
- ④ Cable shoe

If necessary, a second washer can be used in front of the cable shoe.

Hold the counter nut firmly using a wrench (as shown in Figure III-6). Use a SW 17 wrench for the Han® HC Modular 350 or SW 24 for the Han® HC Modular 650 to protect the contact against tightening torque.

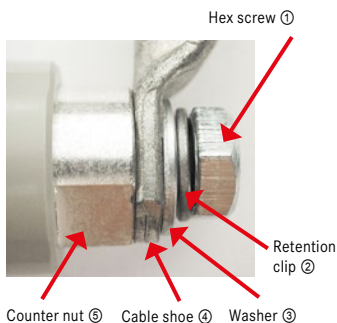
For both high-current contacts, Han® HC Modular 350 and 650, the recommended torque is exactly 14 Nm.

**Note:**

*The Han® HC Modular 350 / 650 high-current contacts are intended for installation only in the Han® HPR bulkhead-mounted housings!*

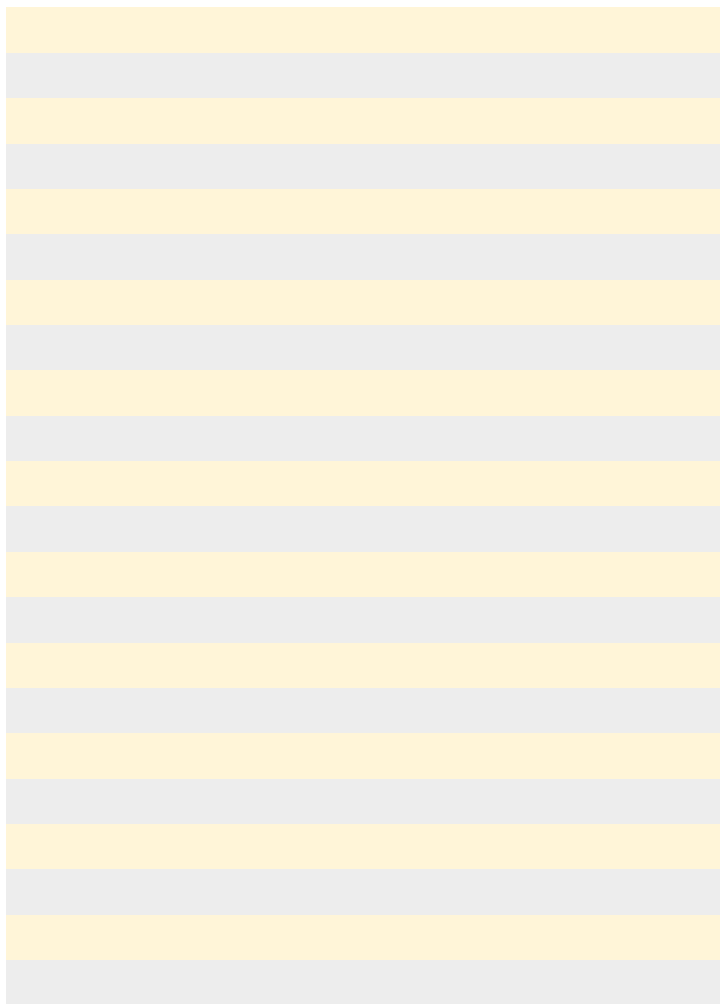


Figure III-6: Han® HC Modular high-current contact with contact shoe



## Notes

III



---

## IV. Axial screw termination technology

### Table of Contents

1. Overview of the axial screw termination .....	28
2. Advantages .....	28
3. Application areas .....	29
4. Normative requirements: wire gauges .....	29
5. Stripping lengths, tightening torques, relevant series .....	31
6. Assembly .....	36
6.1 Tools .....	36
6.2 Information on using assembly tools .....	37
6.3 Assembly notes* .....	38
6.4 Strain relief .....	39
6.5 Maintenance of terminal connections.....	40
6.6 Correct positioning of the cable.....	40
7. Assembly of cables with large outer diameters .....	41

## 1. Overview of the axial screw termination

The special feature of the axial screw termination is that the fixing screw for the cable is on a level axially with the contact and the cable. The cable is connected using a conical (axial) screw that penetrates axially into the stranded wire and pushes the single strands against the inside of the contact termination area until they are firmly clamped between the cone and contact termination area (see Figure IV-1).

IV

The axial screw termination technology can also be chosen for fine stranded wires. However, it was designed for space-saving termination of wires with large wire gauges without using any special tools. Wire gauges up to a maximum of 185 mm<sup>2</sup> can be processed. The termination is highly reliable. The technology is particularly insensitive to the impact of shock and vibration, which is an important criterion, for example, for the railway industry.

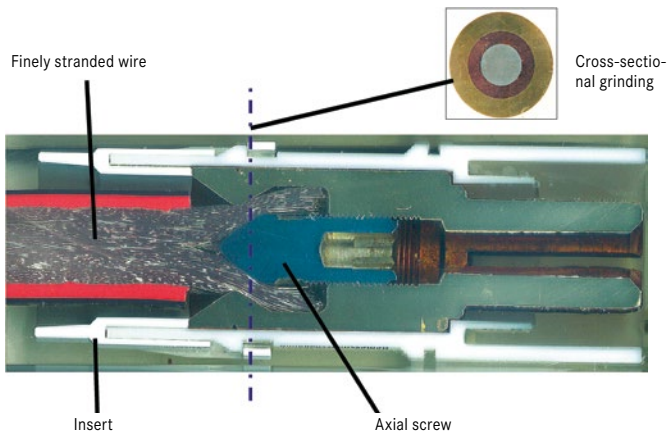


Figure IV-1: Microsection of axial-screw contact (longitudinal + cross-sectional grinding)

## 2. Advantages

- ⊕ Minimal space requirement
- ⊕ Easy handling
- ⊕ Large cross-section range
- ⊕ No special tools needed

### 3. Application areas

The axial screw termination is primarily for applications in the areas of transport technology, wind energy, power generation and distribution, mechanical engineering, robotics and automation technology, in which high currents between 40 and 650 amps are transmitted.

### 4. Normative requirements: wire gauges

IV

The axial screw technology is suitable for fine and super fine stranded wires in accordance with IEC 60 228 Class 5+6 (see Table IV-1, p. 30: Wire structure as per IEC 60 228). Deviating cable designs must be tested separately. The specified wire gauges refer to the geometric cross-section of the cable being used. All data in the table is based on the catalogue “Industrial Connectors Han®”.

According to IEC 60 228 concerning cables and insulated wires, a cable's cross-section is determined by the conductivity ( $\Omega/\text{km}$ ) and the maximum wire diameter. A minimum wire diameter is not specified. In practice, this results in real cross-sections that can differ significantly from the nominal cross-sections, because manufacturers measure the resistance across the cable route (according to the standard).

Example: nominal cross-section =  $35 \text{ mm}^2 \rightarrow$  real, geometric cross-section =  $30 \text{ mm}^2$ . Depending on the material quality, fluctuations occur in cross-sections that lead to different cables of the same nominal cross-section requiring different setting parameters or, in the worst case, the inability to process these with standard contacts and tools.

The geometric cross-section can be determined by the following formula: Cross section = number of single strands \*  $0.785$  \* diameter of single strand<sup>2</sup>. Mathematically, the formula is:

$$A = n * \pi * d^2/4, \text{ where}$$

A = cross-section

n = number of single strands

d = diameter of the single strand

The user can have the cable that he wants to use tested for termination possibilities before assembly. The HARTING laboratory “Corporate Technology Service” is available for the respective tests.

Table IV-1: Structure of wire strands, according to IEC 60 228

Cross-section mm <sup>2</sup>	Stranded wires IEC 60228 class 2	Fine stranded wires IEC 60228 Class 5	Super fine stranded wires IEC 60 228 Class 6			
0.14			18 x 0.10	18 x 0.10	36 x 0.07	72 x 0.05
0.25		14 x 0.15	32 x 0.10	32 x 0.10	65 x 0.07	128 x 0.05
0.34		19 x 0.15	42 x 0.10	42 x 0.10	88 x 0.07	174 x 0.05
0.38		12 x 0.20	21 x 0.15	18 x 0.10	100 x 0.07	194 x 0.05
0.55	7 x 0.30	16 x 0.20	28 x 0.15	64 x 0.10	131 x 0.07	256 x 0.05
0.75	7 x 0.37	24 x 0.20	42 x 0.15	96 x 0.10	195 x 0.07	384 x 0.05
1.34	7 x 0.43	32 x 0.20	56 x 0.15	128 x 0.10	260 x 0.07	512 x 0.05
1.54	7 x 0.52	30 x 0.25	84 x 0.15	192 x 0.10	392 x 0.07	768 x 0.05
2.54	7 x 0.67	50 x 0.25	140 x 0.15	320 x 0.10	651 x 0.07	1280 x 0.05
4.34	7 x 0.85	56 x 0.30	224 x 0.15	512 x 0.10	1040 x 0.07	
6.34	7 x 1.05	84 x 0.30	192 x 0.20	768 x 0.10	1560 x 0.07	
10.34	7 x 1.35	80 x 0.40	320 x 0.20	1280 x 0.10	2600 x 0.07	
16.34	7 x 1.70	128 x 0.40	512 x 0.20	2048 x 0.10		
25.34	7 x 2.13	200 x 0.40	800 x 0.20	3200 x 0.10		
35.34	7 x 2.52	280 x 0.40	1120 x 0.20			
50.34	19 x 1.83	400 x 0.40	705 x 0.30			
70.34	19 x 2.17	356 x 0.50	990 x 0.30			
95.34	19 x 2.52	485 x 0.50	1340 x 0.30			
120,34	37 x 2.03	614 x 0.50	1690 x 0.30			
150,34	37 x 2.27	765 x 0.50	2123 x 0.30			
185,34	37 x 2.52	944 x 0.50	1470 x 0.40			
240,34	61 x 2.24	1225 x 0.50	1905 x 0.40			
300,34	61 x 2.50	1530 x 0.50	2385 x 0.40			
400,34	61 x 2.89	2035 x 0.50				
500,34	61 x 3.23	1768 x 0.60				



## 5. Stripping lengths, tightening torques, relevant series

Wires for connectors must be stripped to a certain length before assembly. Correct stripping fulfils the following functions:

- Maintaining the electrical dielectric strength. If the wire is stripped too short or too long, the overvoltage behaviour of the connector (e.g. the insert) changes and no longer meets the specifications. This can lead to damage in the application.
- Compliance with the maximum contact resistance
- Proper latching of contacts in the insert
- Securing the current-carrying capacity

Axial screws may also only be tightened to a specified tightening torque to comply with wire pull-out forces and contact resistances and to avoid damage to the wire. Stripping lengths and tightening torques for selected inserts and wire gauges can be found in Table IV-2, p. 32.

Table IV-2: Overview of contacts/inserts with axial screw termination

Insert	Wire gauge (mm <sup>2</sup> )	Stripping length (mm)	Tightening torque (Nm)	Max. cable insulation diameter (mm)	Size of hexagon- socket (A/F)	Insert dimension for cable marking (mm)
Han® K 4/4 finger safe	6 – 16	6 mm <sup>2</sup> ; 11+1	6 mm <sup>2</sup> ; 2	8,9	2.5	7.4
		10 mm <sup>2</sup> ; 11+1	10 mm <sup>2</sup> ; 3			
		16 mm <sup>2</sup> ; 11+1	16 mm <sup>2</sup> ; 4			
	10 – 22	10 mm <sup>2</sup> ; 11+1	10 mm <sup>2</sup> ; 3	8,9	2.5	7.4
		16 mm <sup>2</sup> ; 11+1	16 mm <sup>2</sup> ; 4			
		22 mm <sup>2</sup> ; 11+1	22 mm <sup>2</sup> ; 4			
Han® K 4/4	6 – 16	6 mm <sup>2</sup> ; 11+1	6 mm <sup>2</sup> ; 2	8,9	2.5	7.4
		10 mm <sup>2</sup> ; 11+1	10 mm <sup>2</sup> ; 3			
		16 mm <sup>2</sup> ; 11+1	16 mm <sup>2</sup> ; 4			
	10 – 22	10 mm <sup>2</sup> ; 11+1	10 mm <sup>2</sup> ; 3	8,9	2.5	7.4
		16 mm <sup>2</sup> ; 11+1	16 mm <sup>2</sup> ; 4			
		22 mm <sup>2</sup> ; 13+1	22 mm <sup>2</sup> ; 4			
Han® K 6/12	2.5 – 8	2.5 mm <sup>2</sup> ; 5+1	2.5 mm <sup>2</sup> ; 1.5	6.2	2	7.4
		4 mm <sup>2</sup> ; 5+1	4 mm <sup>2</sup> ; 1.5			
		6 mm <sup>2</sup> ; 8+1	6 mm <sup>2</sup> ; 2			
	6 – 10	8 mm <sup>2</sup> ; 8+1	8 mm <sup>2</sup> ; 2	6.2	2	4.7
		6 mm <sup>2</sup> ; 8+1	6 mm <sup>2</sup> ; 2			
		8 mm <sup>2</sup> ; 8+1	8 mm <sup>2</sup> ; 2			
Han® K 6/6	10 – 25	10 mm <sup>2</sup> ; 13+/-1	10 mm <sup>2</sup> ; 6	11.4	4	4.9
		16 mm <sup>2</sup> ; 13+/-1	16 mm <sup>2</sup> ; 6			
		25 mm <sup>2</sup> ; 13+/-1	25 mm <sup>2</sup> ; 7			
	16 – 35	16 mm <sup>2</sup> ; 13+/-1	16 mm <sup>2</sup> ; 6	11.4	4	4.9
		25 mm <sup>2</sup> ; 13+/-1	25 mm <sup>2</sup> ; 7			
		35 mm <sup>2</sup> ; 13+/-1	35 mm <sup>2</sup> ; 8			
Han® K 8/0	10 – 25	10 mm <sup>2</sup> ; 13+/-1	10 mm <sup>2</sup> ; 6	11.4	4	4.75
		16 mm <sup>2</sup> ; 13+/-1	16 mm <sup>2</sup> ; 6			
		25 mm <sup>2</sup> ; 13+/-1	25 mm <sup>2</sup> ; 7			

Table IV-2: Overview of contacts/inserts with axial screw termination

Insert	Wire gauge (mm <sup>2</sup> )	Stripping length (mm)		Tightening torque (Nm)		Max. cable insulation diameter (mm)	Size of hexagon-socket (A/F)	Insert dimension for cable marking (mm)
		2.5 mm <sup>2</sup> ; 4 mm <sup>2</sup> ; 6 mm <sup>2</sup> ; 10 mm <sup>2</sup> ; 4 mm <sup>2</sup> ; 6 mm <sup>2</sup> ; 10 mm <sup>2</sup> ; 25 mm <sup>2</sup> ; 40 mm <sup>2</sup> ; 40 mm <sup>2</sup> ; 70 mm <sup>2</sup> ;	8+1 8+1 8+1 8+1 8+1 8+1 16 16 16 16	2.5 mm <sup>2</sup> ; 4 mm <sup>2</sup> ; 6 mm <sup>2</sup> ; 10 mm <sup>2</sup> ; 4 mm <sup>2</sup> ; 6 mm <sup>2</sup> ; 10 mm <sup>2</sup> ; 25 mm <sup>2</sup> ; 40 mm <sup>2</sup> ; 40 mm <sup>2</sup> ; 70 mm <sup>2</sup> ;	1.8 1.8 1.8 1.8 1.8 1.8 8 8 9 10			
Han® Q.2/0 Han® Q.2/0 High Voltage	2.5 – 10	2.5 mm <sup>2</sup> ;	8+1	2.5 mm <sup>2</sup> ;	1.8	7.3	2	5.6
		4 mm <sup>2</sup> ;	8+1	4 mm <sup>2</sup> ;	1.8			
		6 mm <sup>2</sup> ;	8+1	6 mm <sup>2</sup> ;	1.8			
Han® Q.4/2 Han® Q.4/2 with Han-Quick Lock®	4 – 10	10 mm <sup>2</sup> ;	8+1	10 mm <sup>2</sup> ;	1.8	7.3	2	5.6
		4 mm <sup>2</sup> ;	8+1	4 mm <sup>2</sup> ;	1.8			
		6 mm <sup>2</sup> ;	8+1	6 mm <sup>2</sup> ;	1.8			
Han® 200 A module Han® 200 A module with PE	25 – 40 40 – 70	25 mm <sup>2</sup> ;	16	25 mm <sup>2</sup> ;	8	12 16 12	5	0
		40 mm <sup>2</sup> ;	16	40 mm <sup>2</sup> ;	8			
		40 mm <sup>2</sup> ;	16	40 mm <sup>2</sup> ;	9			
Han® 100 A module	6 – 10 10 – 25 16 – 35	70 mm <sup>2</sup> ;	16	70 mm <sup>2</sup> ;	10	11.4	2.5	4.9
		6 mm <sup>2</sup> ;	13+/-1	6 mm <sup>2</sup> ;	4			
		8 mm <sup>2</sup> ;	13+/-1	8 mm <sup>2</sup> ;	4			
Han® 100 A module	10 – 25	10 mm <sup>2</sup> ;	13+/-1	10 mm <sup>2</sup> ;	4	11.4	4	4.9
		16 mm <sup>2</sup> ;	13+/-1	16 mm <sup>2</sup> ;	6			
		25 mm <sup>2</sup> ;	13+/-1	25 mm <sup>2</sup> ;	7			
Han® 100 A module	16 – 35	16 mm <sup>2</sup> ;	13+/-1	16 mm <sup>2</sup> ;	6	11.4	4	4.9
		25 mm <sup>2</sup> ;	13+/-1	25 mm <sup>2</sup> ;	7			
		35 mm <sup>2</sup> ;	13+/-1	35 mm <sup>2</sup> ;	8			
Han® 70 A module	6 – 16 14 – 22	38 mm <sup>2</sup> ;	13+/-1	38 mm <sup>2</sup> ;	8	8.9 10	2.5	5.9
		6 mm <sup>2</sup> ;	11+1	6 mm <sup>2</sup> ;	2			
		10 mm <sup>2</sup> ;	11+1	10 mm <sup>2</sup> ;	3			
Han® 70 A module	14 – 22	16 mm <sup>2</sup> ;	12.5+1	16 mm <sup>2</sup> ;	4	10	2.5	5.9
		14 mm <sup>2</sup> ;	12.5+1	14 mm <sup>2</sup> ;	4			
		16 mm <sup>2</sup> ;	12.5+1	16 mm <sup>2</sup> ;	4			
		22 mm <sup>2</sup> ;	12.5+1	22 mm <sup>2</sup> ;	4			

Table IV-2: Overview of contacts/inserts with axial screw termination

Insert	Wire gauge (mm <sup>2</sup> )	Stripping length (mm)	Tightening torque (Nm)	Max. cable insulation diameter (mm)	Size of hexagon-socket (A/F)	Insert dimension for cable marking (mm)
Han® 40 A module	2.5 mm <sup>2</sup>	5+1	2.5 mm <sup>2</sup> : 1.5	4		
	4 mm <sup>2</sup>	5+1	4 mm <sup>2</sup> : 1.5	4		
	6 mm <sup>2</sup>	8+1	6 mm <sup>2</sup> : 2	6	2	4,7
	8 mm <sup>2</sup>	11+1	8 mm <sup>2</sup> : 2	10.5		
Han® C module with axial screw termination	6 mm <sup>2</sup>	8+1	6 mm <sup>2</sup> : 2	6	2	4,7
	10 mm <sup>2</sup>	11+1	10 mm <sup>2</sup> : 2	10.5		
	2.5 mm <sup>2</sup>	5+1	2.5 mm <sup>2</sup> : 1.5	4		
	4 mm <sup>2</sup>	5+1	4 mm <sup>2</sup> : 1.5	4		
Han® K 3/0 straight	6 mm <sup>2</sup>	8+1	6 mm <sup>2</sup> : 2	6	2	5,2
	8 mm <sup>2</sup>	8+1	8 mm <sup>2</sup> : 2	8.2		
	6 mm <sup>2</sup>	8+1	6 mm <sup>2</sup> : 2	6	2	5,2
	10 mm <sup>2</sup>	11+1	10 mm <sup>2</sup> : 2	8.2		
Han® K 3/0 angled	25 - 40	22	25 mm <sup>2</sup> : 8 40 mm <sup>2</sup> : 8	15	5	8,2
	35 - 70	22	35 mm <sup>2</sup> : 8 50 mm <sup>2</sup> : 9 70 mm <sup>2</sup> : 10	15	5	8,2
	25 - 40	22	25 mm <sup>2</sup> : 8 40 mm <sup>2</sup> : 8	15	5	9
	35 - 70	22	35 mm <sup>2</sup> : 8 50 mm <sup>2</sup> : 9 70 mm <sup>2</sup> : 10	15	5	9
Han® K 3/2 straight	35 - 70 PE: 25 - 40	22	35 mm <sup>2</sup> : 8 50 mm <sup>2</sup> : 9 70 mm <sup>2</sup> : 10	Power: 15 PE: 10	5	Power: 8.2 PE: 7.2
	25 mm <sup>2</sup>	14	25 mm <sup>2</sup> : 8			
	40 mm <sup>2</sup>	22	40 mm <sup>2</sup> : 8	Power: 15 PE: 10	5	Power: 9.0 PE: 7.2
	35 mm <sup>2</sup>	14	35 mm <sup>2</sup> : 8			
Han® K 3/2 angled	35 - 70 PE: 25 - 40	22	35 mm <sup>2</sup> : 8 50 mm <sup>2</sup> : 9 70 mm <sup>2</sup> : 10	Power: 15 PE: 10	5	Power: 9.0 PE: 7.2
	25 mm <sup>2</sup>	22	25 mm <sup>2</sup> : 8			
	40 mm <sup>2</sup>	22	40 mm <sup>2</sup> : 8			
	35 mm <sup>2</sup>	22	35 mm <sup>2</sup> : 8			

Table IV-2: Overview of contacts/inserts with axial screw termination

Insert	Wire gauge	Stripping length (mm)	Tightening torque (Nm)	Max. cable insulation diameter (mm)	Size of hexagon-socket (A/F)	Insert dimension for cable marking (mm)
	(mm <sup>2</sup> )					
Han® HC Modular 350	20 – 35	19+1	20 mm <sup>2</sup> ; 8	19.5	5	13
		20 mm <sup>2</sup> ; 19+1	35 mm <sup>2</sup> ; 8			
	35 – 70	19+1	35 mm <sup>2</sup> ; 8	19.5	5	13
		35 mm <sup>2</sup> ; 19+1	50 mm <sup>2</sup> ; 10			
		50 mm <sup>2</sup> ; 19+1	70 mm <sup>2</sup> ; 12			
		70 mm <sup>2</sup> ; 19+1	95 mm <sup>2</sup> ; 14			
95 – 120	19+1	120 mm <sup>2</sup> ; 16	19.5	5	13	
	20 mm <sup>2</sup> ; 19+1	35 mm <sup>2</sup> ; 8				
PE contact for Han® HC Modular	35 – 70	50 mm <sup>2</sup> ; 19+1	50 mm <sup>2</sup> ; 10	-	5	-
		70 mm <sup>2</sup> ; 19+1	70 mm <sup>2</sup> ; 12			
		60 mm <sup>2</sup> ; 23+2	60 mm <sup>2</sup> ; 12	27		
Han® HC Modular 650	60 – 70	70 mm <sup>2</sup> ; 23+2	70 mm <sup>2</sup> ; 12	27	8	28
		70 mm <sup>2</sup> ; 23+2	70 mm <sup>2</sup> ; 12			
	70 – 120	95 mm <sup>2</sup> ; 23+2	95 mm <sup>2</sup> ; 14	26.5	8	28
		120 mm <sup>2</sup> ; 23+2	120 mm <sup>2</sup> ; 16			
	150 – 185	150 mm <sup>2</sup> ; 23+2	150 mm <sup>2</sup> ; 17	26.5	8	28
	185 mm <sup>2</sup> ; 23+2	185 mm <sup>2</sup> ; 18				






## 6. Assembly

A correct assembly of termination technology is important so that connectors for an application comply with the required guaranteed characteristics. HARTING also offers the right tool for the assembly of connectors. They are perfectly adapted to the products to be processed and their characteristics and when used correctly ensure a consistently high build quality.

## IV

### 6.1 Tools

Table IV-3: Tools for applications of axial screw termination technology

Product	Features	Product photo
<b>Hexagonal wrench for axial terminal screw</b>		
Hexagonal wrench with tee handle <b>09 99 000 0313</b> <b>09 99 000 0363</b> <b>09 99 000 0364</b> <b>09 99 000 0365</b>	Suitable for... 40 A contacts (SW 2) 100 A contacts (SW 4) 200 + 350 A contacts (SW 5) 650 A contacts (SW 8)	
Hexagonal wrench 1/4" bit <b>09 99 000 0369</b> <b>09 99 000 0375</b>	Suitable for... 40 A contacts (SW 2) 70 A contacts (SW 2.5)	
Hexagonal adapter 3/8" <b>09 99 000 0370</b> <b>09 99 000 0371</b> <b>09 99 000 0372</b>	Suitable for... 100 A contacts (SW 4) 200 + 350 A contacts (SW 5) 650 A contacts (SW 8)	
Torque set for high-current axial contact <b>09 99 000 0833</b>	Suitable for... 100 A contacts (SW 4) 250-350 A contacts (SW 5)	
Torque set for power contact <b>09 99 000 0834</b>	Suitable for... - 40 A contacts (SW 2) - 70 A contacts (SW 2.5)	

## 6.2 Notes on using the assembly tools

Tighten the axial screw with a torque wrench. **Observe the tightening torque specified in Table IV-2, p. 32 et seqq.!** This is the only way to ensure a gas-tight, largely corrosion protected connection of the copper strand and consistently good transmission properties throughout the entire working life of the connector.

### Note:

*Use the hex key with T-handle supplied by HARTING only for pre-assembly of high-current contacts! For final assembly, you need a hexagon wrench with torque indicator.*

#### **Danger!**

#### **Danger to life due to electric shock if the wrong tool is used!**

- ▶ Hex tools with ball head can damage the contact safety device of high-current contacts of the Han<sup>®</sup> HC Modular 350 and HC Modular 650 – see Figures IV-3 and IV-4.
- ▶ Use only hexagonal adapter with straight shape as shown in Figure IV-2!



Figure IV-2: Hexagonal adapter, straight



Figure IV-3: Hexagonal adapter with ball head

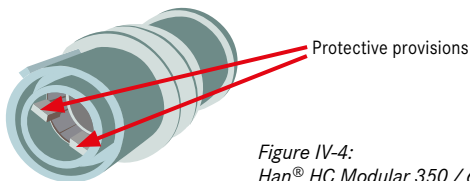


Figure IV-4:  
Han<sup>®</sup> HC Modular 350 / 650

### 6.3 Assembly notes

The following applies to the axial screw termination technology - as for all other termination methods - clean and correct processing is important for the reliability of a connection. Table IV-2, p. 32 et seqq., contains details on wire gauges, stripping lengths and required tightening torques for the listed inserts. The specified wire gauges refer to the geometric cross-section of the cable being used. The HARTING catalogue "Industrial Connectors Han®" is binding.

IV

Assembly steps for terminating cables to contacts with the axial screw termination technique:

- ① Strip the stranded wire in accordance with the specified information (see Table IV-2, p. 32 et seqq.) and do not twist the stripped ends.
- ② Make sure that the tapered screw in the contact is completely in the loosened position.
- ③ Push stranded wire all the way into the contact chamber and hold it firmly.

**Note:**

*If necessary, work with cable marking, as in Figure IV-6, p. 39.*

- ④ Tighten the hexagon socket screw of the mating side using the proper torque wrench. The maximum tightening torque - according to Table IV-2, p. 32 et seqq., - depends on the wire gauge.
- ⑤ Avoid torsional stress and excessive bending of the stranded wire at the termination point!

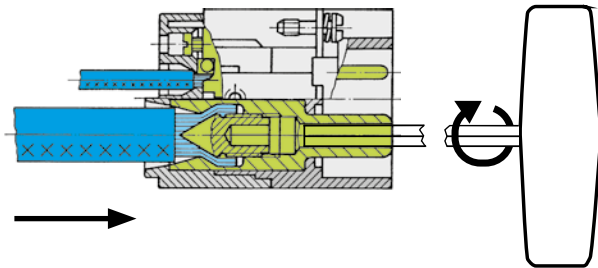


Figure IV-5: Termination principle for the axial screw termination technology

**Note:**

Assembly instructions for axial screw technology in video format can be found under:  
<http://www.harting.com/service/videos/video-presentationen/>



## 6.4 Strain relief

Connectors must be protected from harmful pulling and torsional forces. Pulling forces can be caused by pulling on the cable, but also by the weight of cable and connector. Torsional forces are resulting from twisting the cable. Both forces can impair the contact. Prevent damage by using cable clamps and fix the wires at a suitable distance from the termination point! Notes on correct execution are specified in DIN VDE 0100-520:2003-06 (see Table IV-4).

Table IV-4: Maximum gap for the attachment of easily accessible wires  
(DIN VDE 0100-520: 2003-06)

Outer diameter of the cable [mm]	Maximum gap for the fixing support [mm]	
	Horizontal (x)	Vertical (y)
$D \leq 9$	250	400
$9 < D < 15$	300	400
$15 < D < 20$	350	450
$20 < D < 40$	400	550

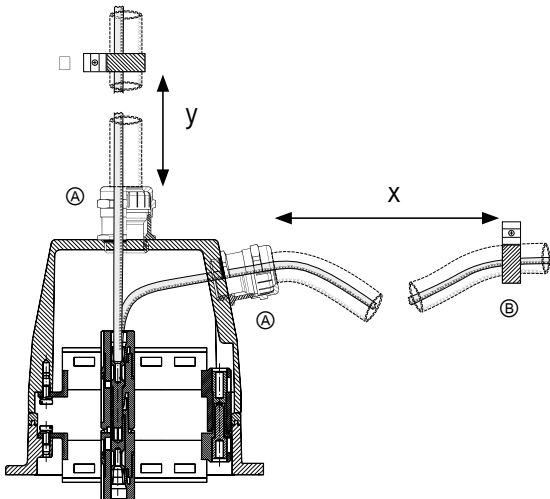


Figure IV-6: Strain relief using cable gland (A) and clamp (B)

## 6.5 Maintenance of axial screw connections

The transition between stranded wire and contact zone of the axial screw is critical to the quality of the connector. The tightening torque drives the axial screw against the stranded wire and pushes it in the clamping ring, so that an optimum transition is created (see Figure IV-5, p. 38, and Chapter IV-5, p. 31).

### Note:

*With multiple applications of the tightening torque, there is a danger that the stranded wires break between screw tip and clamping ring. The torque may therefore be applied only twice on the hexagon socket screw during the working life of an application: after assembly and one more time. Thereafter, the stranded wire must be shortened if necessary and re-stripped.*

## 6.6 Correct positioning of the cable

To correctly enclose the axial screw by the stranded wire, the user must ensure that the cable to be connected is correctly positioned before tightening. Make a mark on the cable sheath: If the cable is pushed into the insert up to the marking (i.e. the marking is flush with the upper edge of the insert) then the cable is in the proper position and may be terminated.

Figure IV-6 illustrates this process using the example of the Han® HC Modular 350 contact. The marking and the upper edge of the insert are at the same level (as indicated by the red line).

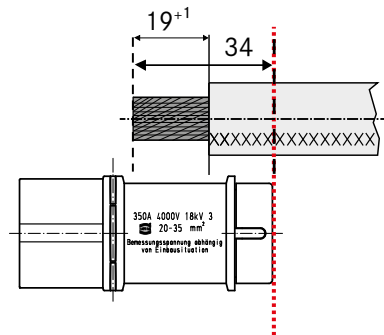


Figure IV-6: Use of the cable marking for cable termination

The dimensions for the marking on the cable sheath are shown in Table IV-2, p. 32 et seqq.

## 7. Assembly of cables with large outer diameters



IV

Figure IV-8: Contacts from the Han® HC Modular 350 and 650 series

The Han® HC Modular 350 and Han® HC Modular 650 contacts are designed for use with cables that have a maximum permissible outside diameter of 19.5 mm and 26.5 mm. This ensures that the necessary creepage and clearance distances for the dielectric strength are adhered to. A shrink tube must be pulled over contacts and transitions to the cable to ensure proper functionality of the contacts even with cables whose outer diameter exceed the maximum permissible values.

There are two possibilities here:

- Shrinking the shrink tube over the contact and the previously inserted cable
- Shrinking the shrink tube over the prepared cable before termination to the contact

Both variants are described below. Depending on the design, one of the two methods can be advantageous with regard to assembly or pre-assembly by the user.

## Shrink tube over contact and previously inserted cable

The following points should be observed for this type of assembly:

- ① Strip the cable according to Figure IV-9 and IV-10, so that the stripped stranded wire can be inserted fully into the contact.
- ② Terminate the cable to the torque specified for the wire gauge (see Table IV-2, p. 32 et seqq.):
  - $\leq 35 \text{ mm}^2$  8 Nm
  - $\leq 50 \text{ mm}^2$  10 Nm
  - $\leq 70 \text{ mm}^2$  12 Nm
  - $\leq 95 \text{ mm}^2$  14 Nm
  - $\leq 120 \text{ mm}^2$  16 Nm
  - $\leq 150 \text{ mm}^2$  17 Nm
  - $\leq 185 \text{ mm}^2$  18 Nm
- ④ Pull the shrink tube as shown in Figure IV-9 and IV-10 (red lines!) over the contact and shrink.

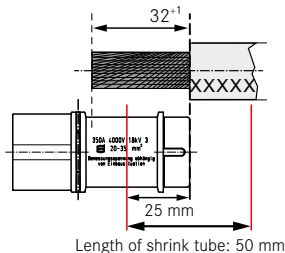


Figure IV-9: Shrink tube assembly over the cable and contact for Han® HC Modular 350

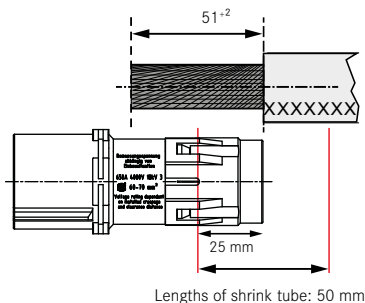


Figure IV-10: Shrink tube assembly over the cable and contact for Han® HC Modular 650

## Shrink tube over the cable to be connected

The following points should be observed for this type of assembly:

- ① Strip the cable according to Figure IV-11 and Figure IV-12.
- ② The following points must be observed when applying the shrink tube directly on the cable:
  - Compliance with the specified stripping length.
  - Compliance with the maximum permissible outer diameter of the cable to be connected.
  - Special care when inserting the prepared cable into the contact chamber, because the stranded wire may possibly splay.
- ③ Terminate the cable to the torque specified for the wire gauge (see Table IV-2, p. 32 et seq.):
  - $\leq 35 \text{ mm}^2$  8 Nm
  - $\leq 50 \text{ mm}^2$  10 Nm
  - $\leq 70 \text{ mm}^2$  12 Nm
  - $\leq 95 \text{ mm}^2$  14 Nm
  - $\leq 120 \text{ mm}^2$  16 Nm
  - $\leq 150 \text{ mm}^2$  17 Nm
  - $\leq 185 \text{ mm}^2$  18 Nm

IV

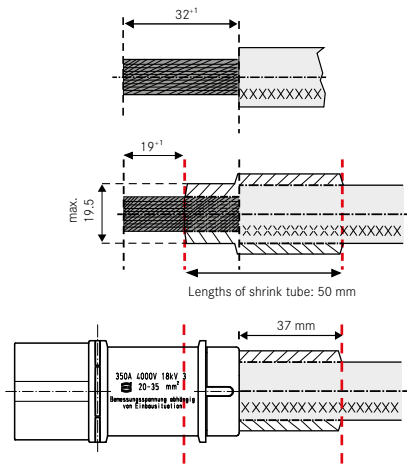


Figure IV-11: Shrink tube assembly over the cable for Han® HC Modular 350

IV

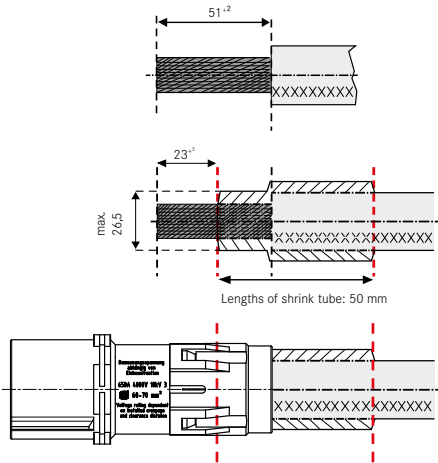


Figure IV-12: Shrink tube assembly over the cable for Han® HC Modular 650

## V. Crimp termination

### Table of Contents

1. Introduction .....	46
2. Features of the crimp contacts .....	46
3. Advantages of the crimp termination technique .....	47
4. Standards and guidelines for the crimping technology .....	48
4.1 Standard DIN EN 60 352-2 .....	48
4.2 Test for the wire pull-out forces .....	49
4.3 Assessment with the help of cross-sections .....	51
4.4 Measuring the crimp heights (open barrel crimping, B-form crimping) .....	53
4.5 Visual inspection – position of the wire in the crimp contact.....	54
5. Overview of crimp tool (closed barrel crimping).....	56
5.1 Manual crimp tools/machines according to cross-section .....	56
5.2 HARTING Crimp tools/die and application areas .....	59
6. Crimp tools for DIN 41 612/interface contacts (open crimping) .....	67
7. Overview of stripping lengths and insulation diameters.....	70
8. Overview of crimping tools.....	71
8.1 Crimping machines for turned contacts.....	71
8.2 Crimping machines for reel-packaging contacts .....	75
9. Operating instructions for HARTING crimp tools.....	76
9.1 Four-indent crimp tool 09 99 000 0888.....	76
9.2 HARTING Crimping tool 09 99 000 0110.....	84
9.3 Operating instructions for service crimp tool 09 99 000 0021.....	85
9.4 Operating instructions for crimp tool 09 99 000 0303 .....	89
9.5 Operating instructions for crimp tool 09 99 000 0377 .....	91
9.6 Crimp tool for D-Sub reel-packaged contacts 09 99 000 0169 .....	94
9.7 HARTING crimp tool 09 99 000 0620 for stamped contacts BC and FC according to DIN 41 612.....	96
9.8 HARTING service crimp tool 09 99 000 0191 for FC individual contacts .....	98
10. Assembly and disassembly instructions .....	100
10.1 Assembly of contacts.....	100
10.2 Removal of contacts .....	101



## 1. Introduction

V The requirements for electrical contacting are varied. In addition to the permanently good mechanical strength, low electrical *contact resistances* are important because they ensure low power dissipation and a low signal distortion based on the application. The material connection between crimp barrel and *stranded wire* is *gas-tight* (see Chapter IV-5, p. 31), and must therefore be carried out very precisely and consistently. The goal is a consistent and reproducible quality. The termination type must also be efficient and economical, which is what the quantity-optimised HARTING tool solutions provide particularly well.

A professionally executed crimp connection meets these requirements. Appropriate processing tools are required for this; tools that, depending on the number and position in the process, can extend from the hand crimp tool to fully automatic crimping machines. This chapter explains what type of technical equipment is required, what the individual steps are and in particular how crimping itself works.

## 2. Features of the crimp contacts

### Open and closed barrel crimping

Crimp terminals can be divided into open (punched rolled) and closed (turned) contacts (see microsections in Chapter V-4.3, p. 51 et seq.). Open crimp contacts are frequently used for applications in electronics with relatively low currents. They are offered mainly as linked reel packaging because the processed quantities are quite high. At higher currents, as often occurs in industrial applications with Han® connectors, individual turned contacts are used that allow a higher current load for the same cross-section.

### Multiple strands in a crimp contact

You can crimp several *stranded wires* as required in one contact, please note the following:

- The cross-section of the crimp contact must be appropriate in relation to the total cross-section of the single strands.
- The contact resistances defined in DIN EN 60352-2 and *pull-out forces* must be met (see Table V-1, p. 50).
- Be sure to maintain the creepage and clearance distances according to the relevant standards.



### 3. Advantages of the crimp termination technique

A perfectly crimped connection is both gas-tight and therefore corrosion-resistant. Performs just like a cold weld. The key criterion for a high-quality crimped connection is the mechanically firm seating achieved by the stranded wire within the contact's connecting element. It provides information about the quality of the crimp connection and determines the contact resistance and the corrosion resistance of the connection.

The economic and technical advantages of the crimp termination technique are:

- Gas-tightness:

A gas-tight connection is characterised by a very strong compression between wire and crimp contact. The two components are so severely deformed that no gaps exist.

As a result, neither a liquid nor a gaseous medium can penetrate the crimp area. This effect prevents oxidation between the individual wires, and results in a constant contact resistance.

- Constant crimping quality thanks to high reproducibility:

Through the use of professional HARTING crimp tools, a high reproducibility of the crimping results is ensured. This leads to an excellent process reliability and guarantees a long working life of the crimp connection.

- Significantly higher wiring speed compared to other termination techniques:

The use of crimping machines allows a high level of automation in the wiring process, thus reducing manual operations. This increases the wiring speed and reduces labour costs per interface.

- Pre-assembly of cable harnesses with crimp contacts:

Through the option of pre-assembly, the location where the wire harness is produced can be separate from the location where it is assembled in the interface of the system.

- Compact, space-saving termination technique:

The crimp termination technique permits very high contact densities compared to, for example, the screw termination technique.

V

## 4. Standards and guidelines for the crimping technology

A properly executed crimp connection is characterized by a reproducible, constant quality in terms of its mechanical and electrical characteristics. That makes this termination technique particularly interesting for the production of large production series.

V

To achieve these high quality characteristics, there are various influencing factors to take into account. The following must be noted:

- Material of the contact material (elasticity, hardness, conductivity)
- Compliance of geometric cross-sections for the contact and wire
- Select the right crimp tool for the crimp contact being used
- Correct setting of the tools, checking for wear, regular maintenance
- Proper stripping of the stranded wire
- Use of suitable stranded wire (fine strand, class 5)

Moreover, there are significant test methods that are sound for assessing the quality of crimp connections.

- Measurement of the pull-out force of a crimp connection
- Analysis of the cross-section
- Measurement of the specified crimp heights or depths (only for open crimping)
- Visual inspection of the contact
- Determination of contact resistance
- Checking the stripping length and depth

### 4.1 Standard DIN EN 60 352-2

Parameters and test criteria of a crimp connection that has been correctly executed according to the state-of-the-art are described in the above mentioned standard. In addition to testing possibilities that can be relatively easily performed by the user, it also describes more elaborate tests. These special inspection and test programs are relevant in particular for manufacturers and suppliers of various crimp components and must be carried out as release tests.

In general, users can be certain to create a professional, high-quality crimp connection when they process HARTING crimp contacts with the matching tool offered by HARTING. Additional requirements include matching the crimp contact and the stranded wire to each other and observing the corresponding assembly instructions.

In order to check and justify quality statements using simple and reliable criteria, you should observe DIN EN 60 352-2 when crimping, which is clearly presented in the following section.

## 4.2 Test for the wire pull-out forces

Table V-1 contains the minimum requirements for the *pull-out forces* as a function of the *wire gauge* according to DIN EN 60 352-2.

V

The test of wire pull-out forces as a destructive materials test allows an initial assessment of the quality of the crimp connection to be made. Because it is very simple, this test is frequently used directly for quality control in production. It only requires a so-called pull tester. In this test, the crimped contact including the wire is inserted and then the wire is pulled out of the contact. The device then displays the required pull-out force.

Table V-1: Overview of wire pull-out forces

Cross-section		Pull-out force
mm <sup>2</sup>	AWG	N
0.05	30	6
0.08	28	11
0.12	26	15
0.14		18
0.22	24	28
0.25		32
0.32	22	40
0.50	20	60
0.75		85
0.82	18	90
1.0		108
1.3	16	135
1.5		150
2.1	14	200
2.5		230
3.3	12	275
4.0		310
5.3	10	355
6.0		360
8.4	8	370
10.0		380

**Comments:**

1. For larger wire gauges, the requirements of the standards from NF F 61-030 (10 mm<sup>2</sup> - 70 mm<sup>2</sup>) and DIN EN 61238-1 (95 mm<sup>2</sup> - 240 mm<sup>2</sup>) apply depending on the cross-section.
2. The pull-out forces specified in Table V-1 are, relative to the *wire cross-section*, the minimum tensile strength of a *stranded wire* in the crimp contact; they must be complied with in the tensile strength tests. If the required values are reached with the assembled crimp contacts, the tensile strength of the connection is to be considered flawless.
3. 10 N corresponds to a force of approx. 1 kg.

Table V-2: Pull-out forces according to NF F 61-030 and DIN EN 61 238-1

Cross-section		Pull-out force NF F 61-030	Pull-out force DIN EN 61 238-1
mm <sup>2</sup>	AWG	N	N
16.0	5	1650	
25.0	4	2300	
35.0	2	2800	
50.0	1	3300	
70.0	2/0	3900	
95.0	3/0	-	5400
120.0	4/0	-	7200
150.0	-	-	9000
185.0	-	-	11100
240.0	-	-	14400

V

### 4.3 Assessment with the help of cross-sections

A very good inspection comes from microscopic images of the polished cross-sectional area of the crimp zone. Here, the specimen is cut in the centre of the narrowest cross-section, polished and then etched.

The following pages show a properly crimped contact (Figure V-1, p. 52, and Figure V-5, p. 53, open barrel crimping) as well as typical failure patterns:

- Contact over-crimped with cracking of the contact barrel (Figure V-2)
- Unsymmetrical formation of the cross-sectional area (Figure V-3)
- Contact under-crimped-larger gaps in the cross-section (Figure V-4)

## Four-point crimping (closed barrel crimping)

V



Figure V-1: Cross-section of a flawless sample

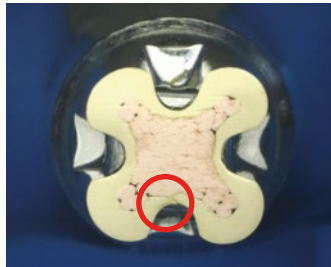


Figure V-2: Cross-section of a defective sample with cracks

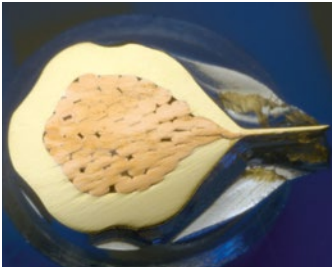


Figure V-3: Cross-section of a defective sample with cracks, extreme asymmetry

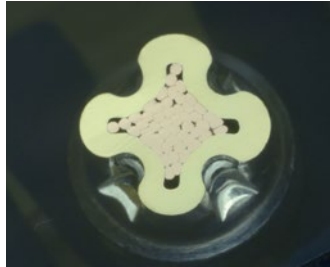


Figure V-4: Cross-section of a defective sample, wire cross-section too small

## B-form crimping (open barrel crimping)

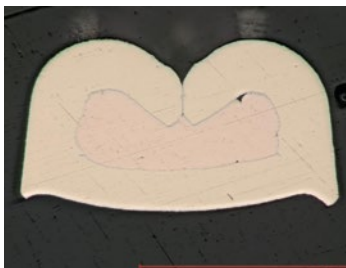


Figure V-5: Cross-section of a flawless sample

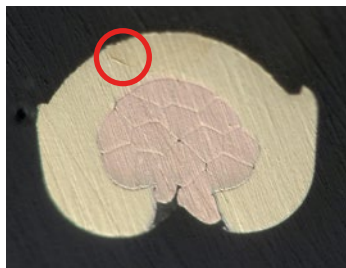


Figure V-6: Cross-section of a defective sample with cracks



Figure V-7: Cross-section of a defective sample, wire cross-section too small

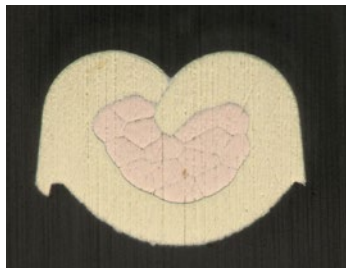


Figure V-8: Cross-section of a defective sample with cracks, unsymmetrical

### 4.4 Measuring the crimp heights (open barrel crimping, B-form crimping)

The crimp height is determined using a micrometer. The crimp contact is placed centrally between the measuring tips. The manufacturer of the contacts specifies the required crimp height. The correct setting of the tool can be seen in the measurement result.

V



Figure V-9: Micrometer screw



Figure V-10: Detail view of crimp contact



Figure V-11: Detail view of a crimp contact between the measuring tips

#### 4.5 Visual inspection – position of the wire in the crimp contact

This test assesses the correct position of the stranded wire in contact and the state of contact after crimping. DIN EN 60 352-2 Chapter 16.4 contains all the required information for proper stripping. The required stripping



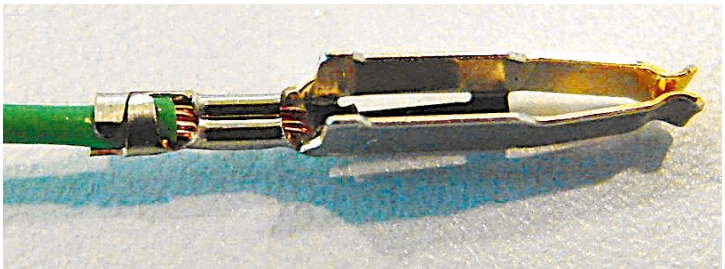
lengths are specified by the contact manufacturer and must always be complied with.

The symmetry and exact position of the crimping and the general state of the contact (straight/bent) can be assessed visually. It is easier to evaluate open rolled, than turned closed contacts. In turned contacts, an inspection hole is, therefore, made, through which it is possible to detect if the stranded wire is at the bottom of the insertion hole. If the stripping length complies with the standard, the inspection hole of the contact is completely filled (see Figure V-12).



*Figure V-12: Turned Han D<sup>®</sup> contact*

- proper stripping (depth + length)
- inspection hole filled
- crimping is uniformly central



*Figure V-13: Stamped FC contract*

- proper stripping
- stranded wire positioned correctly
- insulation crimp enclosed correctly

V

## 5. Overview of crimp tool (closed barrel crimping)

We distinguish between the following series and power ranges:




Series	Max. Rated current
• D-Sub	5 A (7.5 A for turned contacts)
• Han D®	10 A
• Han E®	16 A
• Han® C	40 A
• Han-Yellock®	20 A
• Han® TC	70-650 A

V

### 5.1 Manual crimp tools/machines according to cross-section

Table V-3, p. 57, and Table V-4, p. 58, show which hand crimp tools and crimping machines are suitable for which contacts – depending on the *wire gauge*.

Table V-3: Overview of crimp contacts - manual crimp tools

Crimp terminals	Part number				mm <sup>2</sup>	AWG	Crimping tools						Removal tools	
	Male contact silver plated	Female contact silver plated	Male contact gold plated	Female contact gold plated			09 99 000 0888	09 99 000 0110	09 99 000 0021	09 99 000 0303	09 99 000 0377	09 99 000 0501		20 99 000 1035
Han D <sup>®</sup> signal contacts 09 15 000 .... 	6107	6207	6127	6227	0.14 - 0.25	26 - 24	x							
	6104	6204	6124	6224				x	x					
	6107	6207	6127	6227	0.37	22	x							
	6104	6204	6124	6224				x	x	x				
	6103	6203	6123	6223	0.5	20	x	x	x					
	6105	6205	6125	6225				x	x	x				
	6102	6202	6122	6222	1.0	18	x	x	x					
	6101	6201	6121	6221				x	x	x				
6106	6206	6126	6226	2.5	14	x								
Han D <sup>®</sup> FO contacts 20 10 001 ....	Male contact 3211 / 3213		Female contact 3221 3222		1 mm POF								x	
Han E <sup>®</sup> power contacts 09 33 000 ... 	6127	6227	6117	6217	0.14-0.37	26 - 22	x							
	6121	6220	6122	6222				x	x	x				
	6114	6214	6115	6215	0.75	18	x	x	x					
	6105	6205	6118	6218				x	x	x				
	6104	6204	6116	6216	1.5	16	x	x	x					
	6102	6202	6123	6223				x	x	x				
	6106	6206			3.0	12	x	x						
	6107	6207	6119	6221				x	x					
Han E <sup>®</sup> F.O. contacts 20 10 001 ...	Male contact 3311		Female contact 3321		1 mm POF								x	
Han-Yellock <sup>®</sup> power contacts 11 05 000 .... 	6101	6201	6121	6221	0.14-0.37	26 - 22	x							
	6102	6202	6122	6222				x	x	x				
	6103	6203	6123	6223	0.75	18	x	x	x					
	6104	6204	6124	6224				x	x	x				
	6105	6205	6125	6225	1.5	16	x	x	x					
	6106	6206	6126	6226				x	x	x				
	6107	6207	6127	6227	3.0	12	x	x						
	6108	6208	6128	6228				x	x					
Han <sup>®</sup> C power contacts 09 32 000...	6104	6204			1.5	16	x	x						
	6105	6205						x	x					
	6107	6207			4.0	12	x	x		x				
	6108	6208									x	x		
	6109	6209			10.0	8					x			
D-Sub 09 67 000 8178													x	
<b>Locator</b>														
Locator Han D <sup>®</sup>		09 99 000 0311						x						
		09 99 000 0022							x					
Locator Han E <sup>®</sup>		09 99 000 0310						x						
		09 99 000 0022							x					
Locator Han-Yellock <sup>®</sup>		09 99 000 0342						x						
		09 99 000 0341							x					
		09 99 000 0343								x				
Locator Han <sup>®</sup> C		09 99 000 0308						x						
		09 99 000 0304								x				
Locator Han D <sup>®</sup> , Han E <sup>®</sup> , Han <sup>®</sup> C		09 99 000 0376						x						
Locator D-Sub		09 99 000 0531										x		

V

Table V-4: Overview of crimp contacts - crimping machines

Crimp terminals series	mm <sup>2</sup>	AWG	Crimping machines										
			09 99 000 0813 <sup>2)</sup>	09 99 000 0814 <sup>2)</sup>	09 98 000 6901 <sup>1)</sup>	09 98 000 6902 <sup>1)</sup>	09 98 000 8101 <sup>4)</sup>	09 98 000 8102 <sup>4)</sup>	09 98 000 8103 <sup>4)</sup>	09 98 000 8107 <sup>4)</sup>	09 98 000 9001	09 98 000 9002	09 98 000 9003
Han D® signal contacts 09 15 000 ....	0.14-0.25	26-24			x <sup>5)</sup>		x <sup>5)</sup>				x		
			x										
	0.37	22			x	x					x		
	0.5	20	x	x	x	x					x		
	0.75	18	x	x	x	x					x		
	1.0	18	x	x	x	x					x		
	1.5	16	x	x	x	x					x		
2.5	14			x	x					x			
Han D® FO contacts 20 10 001 ....	1 mm POF												
Han E® power contacts 09 33 000 ...	0.14-0.37	26-22				x <sup>5)</sup>		x <sup>5)</sup>					x
	0.5	20	x			x		x					x
	0.75	18	x			x		x					x
	1.0	18	x			x		x					x
	1.5	16	x			x		x					x
	2.5	14	x			x		x					x
	3.0	12	x			x		x					x
4.0	12	x			x		x					x	
Han E® F.O. contacts 20 10 001 ...	1 mm POF												
Han-Yellock® power contacts 11 05 000 ....	0.14-0.37	26-22									x		
	0.5	20	x								x		
	0.75	18	x								x		
	1.0	18	x								x		
	1.5	16	x								x		
	2.5	14	x								x		
	3.0	12	x										
4.0	12	x											
Han® C power contacts 09 32 000...	1.5	16	x							x			x
	2.5	14	x							x			x
	4.0	12	x							x			x
	6.0	10		x						x			x
	10.0	8		x						x			x

### **Footnotes on Tab V-4:**

#### *Overview of crimp contacts - crimping machines*



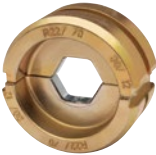
- 1) To operate the interchangeable unit, the TK-M base unit 09 98 000 6900 is required.
- 2) To operate the die, the base device CP 600 09 99 000 0810 is required.
- 3) For Han® power contacts, 10 mm<sup>2</sup>
- 4) To operate the interchangeable unit, the TC-SC base device 09 98 000 8000 is required.
- 5) Depending on the stranded wires




V


## **5.2 HARTING Crimp tools/die and application areas**

The following table (Table V-5, p. 60) indicates the types of contact and in addition the tools/machines that are suitable for the listed crimp tools.

Table V-5: Crimping tools and accessories

Product	Application	Product photo
<b>Crimp tool</b>		
Hydraulic crimping tool with rechargeable battery, 60 kN 09 99 000 0850	For processing TC 70 – TC 650 up to 70 mm <sup>2</sup> , together with 9 mm wide DIN 46 235 dies	
Manually operated hydraulic crimping tool, 60 kN 09 99 000 0851	For processing TC 70 – TC 650 up to 70 mm <sup>2</sup> , together with 9 mm wide DIN 46 235 dies	
10 mm <sup>2</sup> crimping die for 60 kN tool (D6) 09 99 000 0852	Fits to the tools 09 99 000 0850 and 09 99 000 0851	
16 mm <sup>2</sup> crimping die for 60 kN tool (D8) 09 99 000 0853		
25 mm <sup>2</sup> crimping die for 60 kN tool (D10) 09 99 000 0854		
35 mm <sup>2</sup> crimping die for 60 kN tool (D12) 09 99 000 0855		
50 mm <sup>2</sup> crimping die for 60 kN tool (D14) 09 99 000 0856		
70 mm <sup>2</sup> crimping die for 60 kN tool (D16) 09 99 000 0857		

Product	Application	Product photo
<b>Crimp tool</b>		
Hydraulic crimping tool with rechargeable battery, 120 kN 09 99 000 0860	For processing TC 70 – TC 650 up to 240 mm <sup>2</sup> , together with DIN 46 235 jaws	
Manually operated hydraulic crimping tool, 120 kN 09 99 000 0861	For processing TC 70 – TC 650 up to 240 mm <sup>2</sup> , together with DIN 46 235 jaws	
10 mm <sup>2</sup> crimping die for 120 kN tool (D6) 09 99 000 0862	Fits to the tools 09 99 000 0860 and 09 99 000 0861	
16 mm <sup>2</sup> crimping die for 120 kN tool (D8) 09 99 000 0863		
25 mm <sup>2</sup> crimping die for 120 kN tool (D10) 09 99 000 0864		
35 mm <sup>2</sup> crimping die for 120 kN tool (D12) 09 99 000 0865		
50 mm <sup>2</sup> crimping die for 120 kN tool (D14) 09 99 000 0866		

Product	Application	Product photo
<b>Crimp tool</b>		
70 mm <sup>2</sup> crimping die for 120 kN tool (D16) 09 99 000 0867	Fits to the tools 09 99 000 0860 and 09 99 000 0861	
95 mm <sup>2</sup> crimping die for 120 kN tool (D16) 09 99 000 0868		
120 mm <sup>2</sup> crimping die for 120 kN tool (D16) 09 99 000 0869		
150 mm <sup>2</sup> crimping die for 120 kN tool (D18) 09 99 000 0870		
185 mm <sup>2</sup> crimping die for 120 kN tool (D25) 09 99 000 0871		
240 mm <sup>2</sup> crimping die for 120 kN tool (D28) 09 99 000 0872		

V



Table V-6: Contact series and stripping lengths for industrial connectors

**Han D® Crimp contacts (rated current: 10 A)**

	Wire gauge (mm <sup>2</sup> )	Part number	
		Male contacts	Female contacts
 silver plated	0,14-0,37	09 15 000 6104	09 15 000 6204
	0,5	09 15 000 6103	09 15 000 6203
	0,75	09 15 000 6105	09 15 000 6205
	1,0	09 15 000 6102	09 15 000 6202
	1,5	09 15 000 6101	09 15 000 6201
 gold plated	0,14-0,37	09 15 000 6124	09 15 000 6224
	0,5	09 15 000 6123	09 15 000 6223
	0,75	09 15 000 6125	09 15 000 6225
	<b>1,0</b>	09 15 000 6122	09 15 000 6222
	1,5	09 15 000 6121	09 15 000 6221
	2,5	09 15 000 6126	09 15 000 6226

Dimensioned drawing (dimensions in mm)			
Cross-section		Ø	Stripping length of the stranded wire
mm <sup>2</sup>	AWG		
0.14-0.37	26-22	0.90 mm	8 mm
0.5	20	1.10 mm	8 mm
0.75	18	1.30 mm	8 mm
1.0	18	1.45 mm	8 mm
1.5	16	1.75 mm	8 mm
2.5	14	2.25 mm	6 mm

**Han E® Crimp contacts (rated current: 16 A)**

	Wire gauge (mm <sup>2</sup> )	Part number	
		Male contacts	Female contacts
 silver plated	0,5	09 33 000 6121	09 33 000 6220
	0,75	09 33 000 6114	09 33 000 6214
	1,0	09 33 000 6105	09 33 000 6205
	1,5	09 33 000 6104	09 33 000 6204
	2,5	09 33 000 6102	09 33 000 6202
 gold plated	3,0	09 33 000 6106	09 33 000 6206
	4,0	09 33 000 6107	09 33 000 6207
	0,5	09 33 000 6122	09 33 000 6222
	0,75	09 33 000 6115	09 33 000 6215
	1,0	09 33 000 6118	09 33 000 6218
	1,5	09 33 000 6116	09 33 000 6216
	2,5	09 33 000 6123	09 33 000 6223
	4,0	09 33 000 6119	09 33 000 6221

Dimensioned drawing (dimensions in mm)			
Operating contact identification		Relay contact	
Identification	Cross-section mm <sup>2</sup>	AWG	Stripping length of the stranded wire
No groove	0.5	20	7.5 mm
1 groove*	0.75	18	7.5 mm
1 groove	1.0	18	7.5 mm
2 grooves	1.5	16	7.5 mm
3 grooves	2.5	14	7.5 mm
wide groove	3.0	12	7.5 mm
No groove	4.0	12	7.5 mm

**Han D® crimp contacts (rated current: 40 A)**

	Wire gauge (mm <sup>2</sup> )	Part number	
		Male insert (M)	Female insert (F)
 Power contacts	1.5	09 32 000 6104	09 32 000 6204
	2.5	09 32 000 6105	09 32 000 6205
 silver plated	4.0	09 32 000 6107	09 32 000 6207
	6.0	09 32 000 6108	09 32 000 6208
	10,0	09 32 000 6109	09 32 000 6209

Dimensioned drawing (dimensions in mm)			
Cross-section		Ø	Stripping length of the stranded wire a
mm <sup>2</sup>	AWG		
1.5	16	1.75 mm	9, mm
2.5	14	2.25 mm	9, mm
4.0	12	2.85 mm	9.6 mm
6.0	10	3.5 mm	9.6 mm
10,0	8	4.3 mm	15.0* mm

15 mm stripping length for cable  $\geq 5.4$  mm Ø  
 18 mm stripping length for cable  $\geq 6.4$  mm Ø

Table V-7: Han-Yellock® crimp contacts (rated current: 20 A)



	Cross-section	Part no. male contact
 <b>silver plated</b>	0.14 – 0.37	11 05 000 6 101
	0.5	11 05 000 6 102
	0.75	11 05 000 6 103
	1	11 05 000 6 104
	1.5	11 05 000 6 105
	2.5	11 05 000 6 106
	3	11 05 000 6 107
	4	11 05 000 6 108
 <b>Surface gold plated</b>	0.14 – 0.37	11 05 000 6 121
	0.5	11 05 000 6 122
	0.75	11 05 000 6 123
	1	11 05 000 6 124
	1.5	11 05 000 6 125
	2.5	11 05 000 6 126
	3	11 05 000 6 127
	4	11 05 000 6 128

Table V-8: Stripping lengths for Han-Yellock® crimp contacts

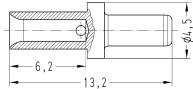






Cross-section		Stripping length of the stranded wire	Drawing
mm <sup>2</sup>	AWG		
0.14 – 0.37	26-22	6.5 mm	
0.5	20	6.5 mm	
0.75	18	6.5 mm	
1	18	6.5 mm	
1.5	16	6.5 mm	
2.5	14	6.5 mm	
3	12	6.5 mm	
4	12	6.5 mm	

Table V-9: Han® TC crimp contacts

TC 70 	Cross-section	Part number	
		Male contact	Female contacts
	10	09 11 000 6131	09 11 000 6231
	16	09 11 000 6132	09 11 000 6232
	25	09 11 000 6133	09 11 000 6233
TC 100 	10	09 11 000 6114	09 11 000 6214
	16	09 11 000 6116	09 11 000 6216
	25	09 11 000 6125	09 11 000 6225
	35	09 11 000 6135	09 11 000 6235
TC 200 	25	09 11 000 6120	09 11 000 6220
	35	09 11 000 6121	09 11 000 6221
	50	09 11 000 6122	09 11 000 6222
	70	09 11 000 6123	09 11 000 6223
TC 250 	25	09 11 000 6126	09 11 000 6226
	35	09 11 000 6127	09 11 000 6227
	50	09 11 000 6128	09 11 000 6228
	70	09 11 000 6129	09 11 000 6229
TC 350 	25	09 11 000 6139	09 11 000 6239
	35	09 11 000 6140	09 11 000 6240
	50	09 11 000 6141	09 11 000 6241
	70	09 11 000 6142	09 11 000 6242
	95	09 11 000 6143	09 11 000 6243
	120	09 11 000 6144	09 11 000 6244
TC 650 	70	09 11 000 6161	09 11 000 6261
	95	09 11 000 6162	09 11 000 6262
	120	09 11 000 6163	09 11 000 6263
	150	09 11 000 6164	09 11 000 6264
	185	09 11 000 6165	09 11 000 6265
	240	09 11 000 6168	09 11 000 6268

V

Table VI-10: Wire gauges and stripping lengths Han® TC crimp

Cross-section		Stripping length of the stranded wire
mm <sup>2</sup>	AWG	
10	8	TC 70: 15.5 mm TC 100: 19 mm
16	6	TC 70: 15.5 mm TC 100: 19 mm
25	4	TC 70: 15.5 mm TC 100: 19 mm TC 200: 19 mm
35	2	TC 100: 16 mm TC 200: 20 mm TC 250: 22 mm TC 350: 26 mm
50	1	TC 200: 22.5 mm TC 250: 22 mm TC 350: 28 mm
70	2/0	TC 200: 22.5 mm TC 250: 22 mm TC 350: 28 mm TC 650: 42 mm
95	3/0	TC 350: 30 mm TC 650: 42 mm
120	4/0	TC 350: 24 mm TC 650: 42 mm
150	300 MCM	TC 650: 42 mm
185	350 MCM	TC 650: 42 mm
240	500 MCM	TC 650: 42 mm

## 6. Crimp tools for DIN 41 612/interface contacts (open crimping)

There are two different hand crimp tools for the various open HARTING crimp contacts of the DIN 41 612 and Interface series. One crimping tool for single contacts and one for reel-packaged contacts. The individual contacts are processed by inserting the crimp into the die. The reel-packaged contacts are processed by manual operation of the indexing unit. The stripped *stranded wire* is positioned and the crimp zone is deformed symmetrically by squeezing the lever of the tool. During processing, the locator fixes the crimp contact between the crimp dies.

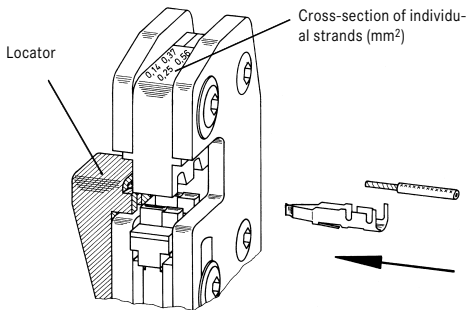


Figure V-14: Feeding of the contact



Figure V-15: Reel-package and individual contacts

V

Table V-11: Overview of manual crimping tools D-Sub

Crimp terminals series	mm <sup>2</sup>	AWG	HARTING crimp tool for reels				HARTING crimping tool for individual contacts				
FC 1	09 06 000 7484	28 - 24								09 99 000 0596	
	09 06 000 7474	28 - 24	x							09 99 000 0175	
	09 06 000 8484	28 - 24	x							09 99 000 0191	x <sup>1</sup>
	09 06 000 8474	28 - 24									x <sup>1</sup>
	09 06 000 9574	28 - 24									x <sup>1</sup>
	09 06 000 9554	28 - 24									x <sup>1</sup>
	09 06 000 7481	26 - 20									x <sup>1</sup>
	09 06 000 7471	26 - 20		x							x <sup>1</sup>
FC 2	09 06 000 8481	26 - 20									x <sup>1</sup>
	09 06 000 8471	26 - 20		x							x <sup>1</sup>
	09 06 000 8481	26 - 20									x <sup>1</sup>
	09 06 000 8471	26 - 20									x <sup>1</sup>
	09 06 000 5541	26 - 20									x <sup>1</sup>
	09 06 000 5541	26 - 20									x <sup>1</sup>
	09 06 000 9571	26 - 20									x <sup>1</sup>
	09 06 000 9551	26 - 20									x <sup>1</sup>
FC 3	09 06 000 7482	20 - 16									x <sup>1</sup>
	09 06 000 7472	20 - 16									x <sup>1</sup>
	09 06 000 8482	20 - 16									x <sup>1</sup>
	09 06 000 8472	20 - 16									x <sup>1</sup>
	09 06 000 5542	20 - 16									x <sup>1</sup>
	09 06 000 9572	20 - 16									x <sup>1</sup>
	09 06 000 9552	20 - 16									x <sup>1</sup>
	BC										
09 02 000 8434	28 - 24										
09 02 000 8444	28 - 24										
09 02 000 8484	28 - 24										x

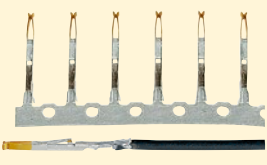


## 7. Overview of stripping lengths and insulation diameters

### BC contacts acc. to DIN 41 612

Table V-12: Overview of stripping lengths and insulation diameters for contact type BC

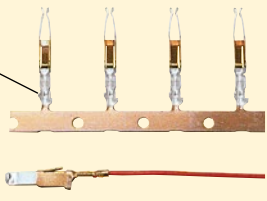
Cross-section		Insulation Ø mm
mm <sup>2</sup>	AWG	
0.09 - 0.25	28 - 20	0.7 - 1.5
Contacts on a reel-package		
Individual contacts		
Stripping length of the stranded wire: 3.5 + 0.5 mm		



### FC contacts acc. to DIN 41 612

Table V-13: Overview of stripping lengths and insulation diameters for contact type FC


Cross-section		Insulation Ø mm	
mm <sup>2</sup>	AWG		
0.09 - 0.25	28 - 24	0.7 - 1.5	FC1
0.14 - 0.56	26 - 20	0.8 - 2.0	FC2
0.5 - 1.5	20 - 16	1.6 - 2.8	FC3
Contacts on a reel-package			
Individual contacts			
Stripping length of the stranded wire: 3.5 + 0.5 mm			



### D-Sub contacts acc. to DIN 41 652

Table V-14: Overview of stripping lengths and insulation diameters for contact D-Sub

Cross-section		Insulation Ø mm
mm <sup>2</sup>	AWG	
0.09 - 0.25	28 - 24	max. 1.02
0.25 - 0.56	24 - 20	max. 1.52
Stripping length of the stranded wire: 2.5 + 0.5 mm		



#### Note:

For D-Sub high density contacts and for special contacts with M form - see "HARTING Device Connectivity" catalogue.



## 8. Overview of crimping tools

HARTING offers crimping machines both for turned individual contacts as well as for stamped strip contacts. A distinction is made between semi- and fully automatic crimping machines. Users with a semi-automatic crimping machine must separately strip the cable during crimping, e.g. to a stripping length or using a hand tool, whereas, with crimping machines, the cable is stripped in one operation and crimped with the crimp contact.

### 8.1 Crimping machines for turned contacts

In addition to hand crimp tools, HARTING offers other tools for turned single contacts:

- two crimping machines
- a semi-automatic machine
- a pneumatic crimp tool

#### HARTING TK-M (crimping machine)

Features/benefits:

- Quick stripping and crimping in a single step
- Easy to operate thanks to well-arranged design and operation via touchscreen
- For loose, turned solid male and female contacts (for the HARTING series Han D®, Han E®)
- Optional processing of male and female contacts (wire gauges of 0.14 mm<sup>2</sup> to 4.0 mm<sup>2</sup>, AWG 26 to AWG 12)
- Contact magazine with automatic level control
- Gas-tight crimped connection with a repeatable accuracy that ensures high quality
- Infinitely variable settings (stripping depth, stripping length, crimp depth and feed rate of the crimp contacts)
- Very low setup effort
- Low maintenance effort
- Work cycle: 1.5 s
- Crimp type: crimp tool with 4 notches



Figure V-16: TK-M crimping machine  
(09 98 000 6900)

### BK crimping machine (fully automatic machine)

V

- Quick stripping and crimping in a single step
- Easy handling due to quick-change tool and stripper
- For HARTING crimp contacts D-Sub, FC, BC ...
- Optional use of male and female contacts
- Wire gauges of 0.09 mm<sup>2</sup> to 0.5 mm<sup>2</sup>, AWG 28 to AWG 20
- Automatic extraction of insulation remnants
- Equipped with crimp force monitoring
- Setting parameters with notched rotary head (stripping depth, stripping length, wire crimp height, insulation crimp height, wire holder, reel-package indexing unit and positioning of the stranded wire in the crimp contact)
- Work cycle: 0.35 s

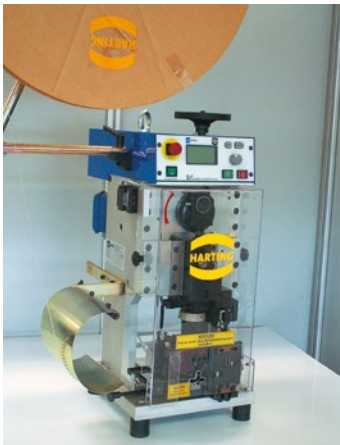


Figure V-17: TYPE BK crimping machine (fully automatic machine)

### HARTING TC-C01 (semi-automatic machine)

- Easy to operate thanks to well-arranged design
- Optional processing of HARTING male and female contacts (wire gauges of 0.14 mm<sup>2</sup> to 10.0 mm<sup>2</sup>, AWG 22 to AWG 12)
- Automatic feeding of the contact
- Gas-tight crimped connection with a repeatable accuracy that ensures high quality
- Minimal setup effort
- Setting up the crimp height without tools
- Low follow-up costs for maintenance and repair
- Work cycle: 1 s
- Crimp type: crimp tool with 4 notches



Figure V-18: TC-C01, semi-automatic machine

## Pneumatic crimp tool PC 600 (semi-automatic machine)

The pneumatic crimp tool CP 600 is used for processing solid, turned (machined) crimp contacts from the Han<sup>®</sup> C, Han D<sup>®</sup>, Han E<sup>®</sup>, and Han-Yellock<sup>®</sup> series.

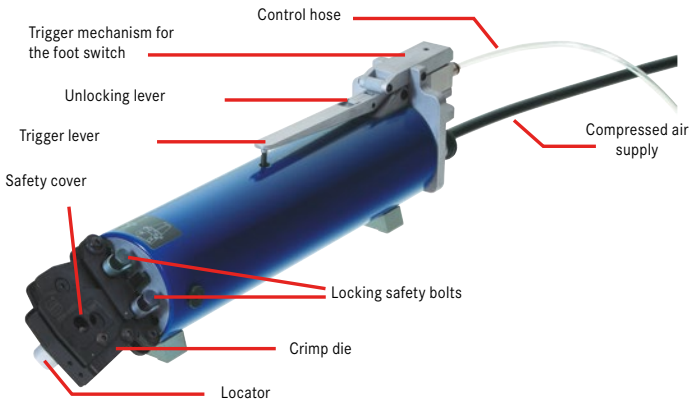


Figure V-19: Overview of a CP 600 pneumatic crimp tool from HARTING

### Technical details for CP 600

Parameters	Type/value
Permissible compressed air supply:	Oiled compressed air at 6 – 8 bar (8 bar for Han <sup>®</sup> C contacts)
Compressed air consumed per cycle at 6 bar:	0.83 l
Recommended lubricator:	Festo LOE-1/8-D-MINI-159620 or equivalent models from other manufacturers
Lubricator dosage:	1 drop/hour
Crimping cycle time:	Max. 1 second (depending on compressed air supply)
Weight:	1.5 kg (including die)
Temperature:	-20 °C - +40 °C
Length:	680 mm
Diameter:	65 mm

## Components

The CP 600 pneumatic crimping tool from HARTING:

- A main unit including 2.5 m PUR compressed air hose and carrying case (09 99 000 0810)
- Die for the Han<sup>®</sup> C (wire gauge  $\leq 4 \text{ mm}^2$ ), Han D<sup>®</sup>, Han E<sup>®</sup>, Han E<sup>®</sup> relay contacts, Han-Yellock<sup>®</sup>, including locator (09 99 000 0813)
- Die for the Han<sup>®</sup> C (wire gauge: 6 – 10  $\text{mm}^2$ ), including locator (09 99 000 0814)
- Foot switch (09 99 000 0811)
- Table clamp (09 99 000 0812)

V



Figure V-20: Die for the Han<sup>®</sup> C, including locator

Figure V-15: Overview of a CP 600 pneumatic crimp tool from HARTING

Part number	Product	Comment
<b>HARTING crimping tool (main unit)</b>		
09 99 000 0810	Main pneumatic unit CP 600 crimping tool	Includes 2.5 m PUR compressed air hose and 3 locators, delivered in a plastic case
<b>Dies</b>		
09 99 000 0813	Die for: Han D <sup>®</sup> , Han <sup>®</sup> C, Han E <sup>®</sup> , Han E <sup>®</sup> relay contacts, Han-Yellock <sup>®</sup>	for crimp contacts/ cross-sections: Han D <sup>®</sup> 0.14...1.5 $\text{mm}^2$ / AWG 26...16 Han E <sup>®</sup> 0.5...4.0 $\text{mm}^2$ / AWG 20...12 Han <sup>®</sup> C 1.5...4.0 $\text{mm}^2$ / AWG 16...12 Han E <sup>®</sup> relay contacts 0.75...2.5 $\text{mm}^2$ / AWG 18...14 Han-Yellock <sup>®</sup> 0.5...4.0 $\text{mm}^2$ / AWG 20...12
09 99 000 0814	Die for Han <sup>®</sup> C	For crimp contacts/cross-sections: Han <sup>®</sup> C 6.0... 10.0 $\text{mm}^2$ / AWG 10...8
<b>Accessories</b>		
09 99 000 0811	Foot switch	
09 99 000 0812	Table clamp	Includes hex (Allen) key for installation
09 99 000 0839	Locator for Han E <sup>®</sup> relay contacts	
09 99 000 0812	Locator for Han-Yellock <sup>®</sup>	

## 8.2 Crimping machines for reel-packaging contacts

Table V-16: Crimping machines for industrial, DIN 41 612, interface crimp contacts

Crimp terminals/ series	mm <sup>2</sup>	AWG	BK crimping machine 09 98 000 500 (basic device)						HARTING Semi- automatic crimping machine <sup>1)</sup>
			09 98 000 3004	09 98 000 3005	09 98 000 3006	09 98 000 3007	09 98 000 3008	09 98 000 3009	09 98 000 3012
FC 1	0.09 - 0.25	28 - 24	x						x
FC 2	0.14 - 0.56	26 - 20			x				x
FC 3	0.50 - 1.50	20 - 16				x			x
BC	0.09 - 0.25	28 - 24	x						x
D-Sub	0.09 - 0.25	28 - 24					x		x
	0.25 - 0.56	24 - 20					x		x

V

### Footnote

<sup>1)</sup> Drive unit with foot switch 115/230 V - 50 Hz. Semi-automatic machine used with roll holder as standard 09 99 000 0158 - for 2500 contacts FC 1, FC 2 or FC 3 and for 5000 contacts BC / har-bus<sup>®</sup> 64.



Figure V-21: HARTING semi-automatic crimping machine 09 99 000 0246

## 9. Operating instructions for HARTING crimp tools

### 9.1 Four-indent crimp tool 09 99 000 0888

#### Usage and safety

HARTING's four-indent crimp tool 09 99 000 0888 (hereinafter referred to as the crimp tool) creates crimp connections between stranded wires and contacts for Han<sup>®</sup> industrial connectors. This crimp tool can be used to process unattached, machined, solid male and female contacts from the Han D<sup>®</sup>, Han E<sup>®</sup>, Han<sup>®</sup> C and Han-Yellok<sup>®</sup> series for wire cross-sections of 0.14 mm<sup>2</sup> to 4 mm<sup>2</sup> (AWG 26 to 12).

The crimp tool features a rotary locator used to properly position the crimping zone between the die jaws. These operating instructions list the settings parameters for the crimping depths (see Setting parameters crimp depth, p. 46); these can also be found directly on the locator. It is not necessary to check the crimping depth. The go/no-go gauge (09 99 000 0889) can be used to check the crimp tool.

The crimp tool may only be used when it is in proper technical condition. It may only be operated in a proper and safe manner. The manufacturer is precluded from liability for damages that result from unauthorized alterations or improper use of this tool.

#### Included in delivery

- HARTING four-indent crimp tool (09 99 000 0888) with integrated rotary locator (as shown in Design of the four-indent crimp tool, p. 77)
- Operating instructions



*Four-indent crimp tool*

### Usage: for contacts

The following contacts and wire cross-sections can be used with this crimp tool:

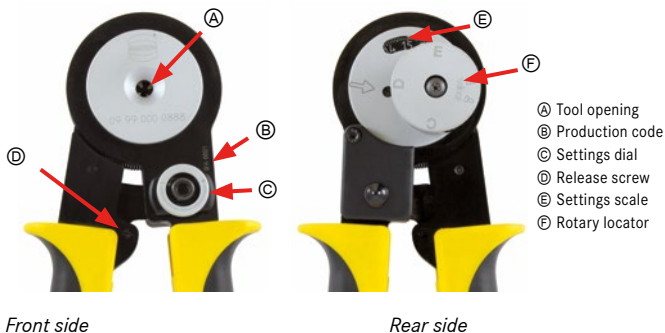
*Contacts, part numbers and stripping lengths*

Han® C		Han D®		Han E®		Han-Yellock®	
<b>Artikelnummer*</b>							
09 32 000 6xxx		09 15 000 6xxx		09 33 000 6xxx		11 05 000 6xxx	
<b>Querschnitt</b>							
(mm <sup>2</sup> )	(AWG)	(mm <sup>2</sup> )	(AWG)	(mm <sup>2</sup> )	(AWG)	(mm <sup>2</sup> )	(AWG)
1,5	16	0,14	26	0,14	26	0,14	26
bis	bis	bis	bis	bis	bis	bis	bis
4,0	12	2,5	14	4,0	12	4,0	12
<b>Abisolierlänge</b>							
9,5 mm		8,0 mm**		7,5 mm		6,5 mm	

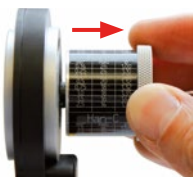
\* Part numbers, see catalogue HARTING industrial connectors Han®

\*\* 2.5 mm<sup>2</sup> = 6.0 mm

### Design of the four-indent crimp tool



### Specifying the locator position



Select the series to be processed – Han D<sup>®</sup>, Han E<sup>®</sup>, Han<sup>®</sup> C or Han-Yellock<sup>®</sup>. Pull the locator out of the latch and turn it until the required marking is lined up with the contact position.

V



The arrow <sup>Ⓐ</sup> will indicate the selected marking. The locator will latch back into position when you release it.



### Adjusting the crimping depth

In order to ensure the best error-free crimp connection, the crimping depth (the gap between the crimping dies) must properly correspond to the type of contact and wire diameter in use. The proper setting must be used. The respective setting can be found on the locator. You can also find it in the table Settings for the crimping depth, p. 79. Han-Yellock<sup>®</sup> 1.5 mm<sup>2</sup> e.g. corresponds to 1.30 mm crimping depth.



## Settings for the crimping depth

### Settings for the crimping depth

Contacts	mm <sup>2</sup>	AWG	Crimping depth
Han D®	0.14	26	1.00
	0.25	24	1.10
	0.37	22	1.20
	0.5	20	1.32
	0.75	18	1.32
	1.0	18	1.35
	1.5	16	1.47
	2.5	14	1.50
Han E®	0.14	26	1.00
	0.25	24	1.00
	0.37	22	1.05
	0.5	20	1.36
	0.75	18	1.36
	1.0	18	1.36
	1.5	16	1.50
	2.5	14	1.60
	3.0	12	1.70
4.0	12	1.80	
Han® C	1.5	16	1.40
	2.5	14	1.50
	4.0	12	1.75
Han-Yellock®*	0.14	26	1.00
	0.25	24	1.00
	0.37	22	1.05
	0.5	20	1.10
	0.75	18	1.20
	1.0	18	1.20
	1.5	16	1.30
	2.5	14	1.55
	3.0	12	1.70
4.0	12	1.80	

\* With the Han Yellock® male and female contacts, different locator settings should be used.

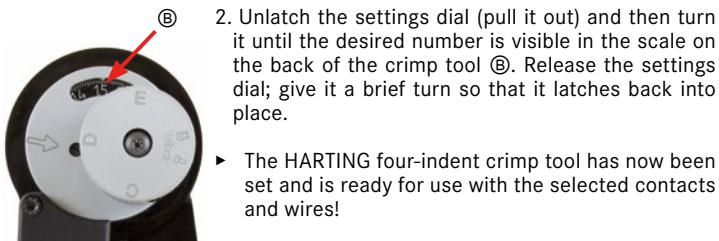
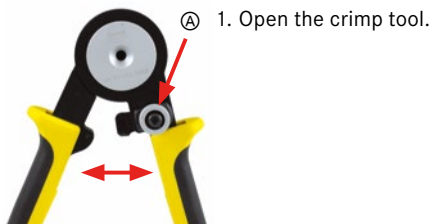
## Preparing the crimp tool

### NOTE

#### Protect against unintentional adjustments

This crimp tool features a settings dial Ⓐ which ensures that the crimping depth cannot be re-adjusted unintentionally. There is no need to set the crimping depth with a plug gauge. When necessary, you may use a go/no-go gauge (09 99 000 0889) to check that the crimp tool is functioning properly.

V



## Crimping



1. Insert the crimp contact into the tool opening (A). The locator ensures that the crimp contact is automatically positioned in the proper crimping position.



2. Insert a properly stripped wire into the crimp contact (B).



3. Press the crimp tool's handles together in order to crimp the contact. Press the handles closed until they automatically reopen (refer also to the chapter Ratchet lock, p. 82).



4. Remove the crimped contact.

### NOTE

#### Checking that the crimp is safe

You should visually inspect each crimp after it has been completed. Check for the proper stripping length, external damage, cracks, etc.

### Ratchet lock

The HARTING four-indent crimp tool (09 99 000 0888) features a ratchet lock **(A)** for ensuring that each crimp contact is produced with consistent quality.



This ratchet lock prevents the crimp tool from being opened prematurely during the crimping process. This ensures a consistent high-quality crimp!

### Early Release

In the event of an operational error, it is possible to release the crimp tool before it has completed the crimp.



Release the pressure off the ratchet by pressing gently on the tool's handles.

- Using a screwdriver, turn the unlocking screw **(B)** counter-clockwise.

Operational errors can happen when the contact is inserted incorrectly or when the wrong contact type is used.

#### NOTE

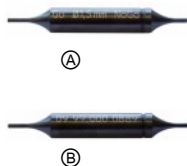
### Opening and releasing in the event of an operational error

Never open or close the four-indent crimp tool with force! Otherwise you endanger the functionality of the crimp tool.

## Maintenance

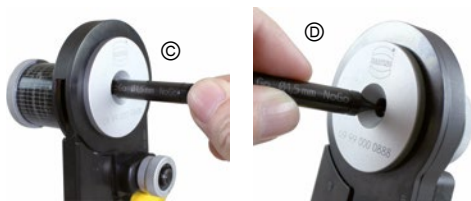
We recommend regularly lubricating all movable parts with an all-purpose oil (e.g. SAE 30 W); this will ensure that your tool has a long service life.

### Checking with the no/no-go gauge



1. Open the crimp tool as shown in chapter Preparing the crimp tool, p. 80).
2. Pull-out the settings dial and turn it until the scale on the back of the crimp tools shows the number 1.5. Release the settings dial; give it a brief turn so that it latches back into place. Release the settings dial; give it a brief turn so that it latches back into place.
3. Check the dimensions of the profile by inserting the no/no-go gauge (A)=front, (B)=back) into the opening!

- It should be possible to insert the “Go” side (C); it should not be possible to insert the “No-Go” side (D).



**Your crimp tool must be re-adjusted by a trained technician if it does not pass this test!**

*Accessories for the four-indent crimp tool*

Accessories	
Designation	Part number
Replacement locator	09 99 000 0887
No/no-go gauge	09 99 000 0889

## 9.2 HARTING Crimping tool 09 99 000 0110

### Operating instructions

The crimp tool 09 99 000 0110 is designed for application of turned HARTING contacts, cross-section range 0.14 – 4.0 mm<sup>2</sup>. For application of these contacts, the crimp tool is equipped with a fixed turn able locator.



V

### Ratchet Mechanism

In order to ensure a constant crimp quality for all contacts the crimp tool is equipped with a releasable safety catch

- It prevents the crimp tool from closing before the crimping dies are fully opened.
- It prevents the tool from being opened prematurely during the crimping process. This ensures that with each crimping operation the specified compression of the contact is achieved.

### Early release

It is possible to effect an early release of the safety device with a screwdriver if the crimp is faulty. The safety device is released by turning right or left. The load must be taken off the dies by applying slight pressure to the handle. Damage the crimping die will thus be prevented if the contact does not lie correctly in the profile.

### Note:

*Do not use force to open and shut the crimp tool. Lubricate all moving parts when needed.*

### Locator

The crimp tool is equipped with a contact-specific locator, which is labelled for the respective connector types.

The required connector type is set by turning the locator.

### Crimping process

- Insert the contact into the proper crimp profile for the cross-section range.
- Secure the contact between the slightly closed crimping dies.
- Crimp the contact by closing the handles until the controlled cycle mechanism release.
- Crimp until the tool opens again.
- Remove the crimped contact.

### 9.3 Operating instructions for service crimp tool 09 99 000 0021

The service crimp tool 09 99 000 0021 can be used with turned HARTING male and female contacts, cross-sectional ranges 0.14 - 2.5 mm<sup>2</sup> (AWG 26 - 14), the Han D<sup>®</sup>, Han E<sup>®</sup> und Han-Yellock<sup>®</sup> series. There are different locators available that can also be ordered separately.

#### Included in delivery:

- Service crimp tool
- Han D<sup>®</sup> locator (loosely enclosed)
- Han E<sup>®</sup> locator (mounted)
- Operating instructions

V

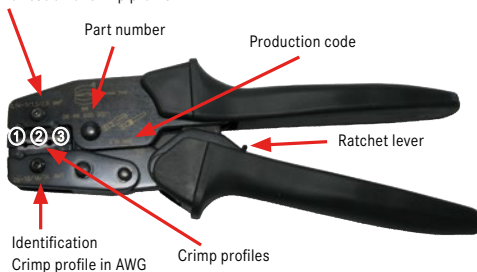
The following table shows which wire gauges can be used with the crimp tool.

*Contacts/wire gauges to be processed*

Series	Wire gauge		Stripping length
	(mm <sup>2</sup> )	AWG	
Han D <sup>®</sup>	0.14 - 1.5 mm	AWG 26 - 16	8 mm
Han E <sup>®</sup>	0.5 - 2.5 mm	AWG 20 - 14	7.5 mm
Han-Yellock <sup>®</sup>	0.5 - 2.5 mm	AWG 20 - 14	6.5 mm

#### Structure of the tool

Identification of crimp profile in mm<sup>2</sup>



*Service crimp tool 09 99 000 0021*

### Crimp profiles\*

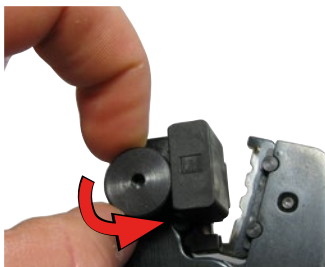
- ① 0.14 - 1 mm<sup>2</sup> (AWG 26 - 18) Han D<sup>®</sup>, Han E<sup>®</sup>, Han-Yellock<sup>®</sup>
- ①② 1.5 mm<sup>2</sup> (AWG 16) Han D<sup>®</sup>, Han E<sup>®</sup>, Han-Yellock<sup>®</sup>
- ③ 2.5 mm<sup>2</sup> (AWG 14) Han E<sup>®</sup>, Han-Yellock<sup>®</sup>

\* Numbering according to image caption, page 85.

### Locator

The different locators can be used on a contact-specific basis and are labelled for the relevant contact type, this ensures that the crimp contact is processed in the correct position (crimp zone). The exchange is very simple, the thumbscrew located on the lower part must merely be loosened and the respective locator mounted.

V



Opening the knurled screw

Series	Part number
Han D <sup>®</sup>	09 99 000 0022 (Set)
Han E <sup>®</sup>	09 99 000 0022 (Set)
Han-Yellock <sup>®</sup>	09 99 000 0343



“D” and “E” stands for suitable Han<sup>®</sup> series



Back side of locator (Han D<sup>®</sup> 2.5 mm<sup>2</sup> closed)



## Crimping

1. Insert the crimp contact into the crimp profile intended. Use the locator to automatically position the crimp contact in the proper crimping position.



- ① Cable cross-section 0.14 - 1 mm<sup>2</sup> (AWG 26 - 18) Han D®, Han E®, Han-Yellock®
- ② Cable cross-section 1.5 mm<sup>2</sup> (AWG 16) Han D®, Han E®, Han-Yellock®
- ③ Cable cross-section 2.5 mm<sup>2</sup> (AWG 14) Han E®, Han-Yellock®

2. Insert the properly stripped stranded wire into the contact and make the crimp by squeezing the tool's handles together until the tool opens again by itself.



3. Remove the crimped contact



**Note:**

*You should visually inspect each crimp after it has been completed!*

**Ratchet Mechanism**

In order to ensure a constant crimp quality for all contacts the crimp tool is equipped with a releasable safety catch

- It prevents the crimp tool from closing before the crimping dies are fully opened.
- It prevents the tool from being opened prematurely during the crimping process. This ensures that with each crimping operation the specified compression of the contact is achieved.

V

**Early crimp unclamp**

It is possible to effect an early release of the safety device with a screwdriver if the crimp is faulty. The safety device is released by turning right or left.

1. Remove the pressure off the tool by pressing gently on the handle.
2. There is a ratchet lever on the movable handle of the tool. Move it toward the lock unit to swing it out from the rack.
3. Open the tool.

**Note: Do not use force to open or close!**

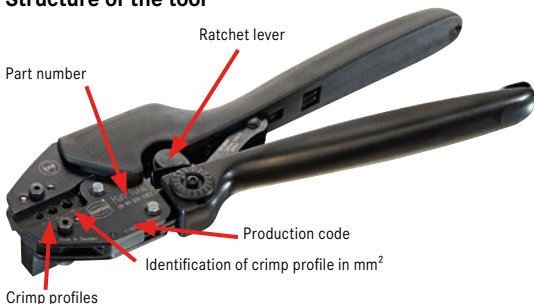
*Do not open or close the service crimp tool with force, otherwise you may damage the ratchet mechanism.*

*Lubricate all moving parts as necessary.*

**When the service crimp tool is used correctly, the required pull-out forces comply with DIN IEC 60 352-2 A2.**

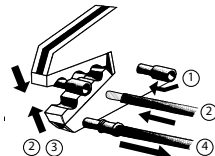
## 9.4 Operating instructions for crimp tool 09 99 000 0303

### Structure of the tool

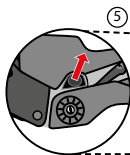


V

### Crimping process



- Open the tool and place the contact into the correct crimp profile ①.
- Close the tool until the contact is held securely in place and insert the stripped wire into the contact ②.
- Squeeze the hand grips together until the ratchet lock releases ③.
- Remove the crimped connection ④.



### Note: Releasing the ratchet mechanism

To release the ratchet mechanism, push the ratchet lever in the direction indicated by the arrow ⑤.

### **Maintenance notes**

- Remove dust, moisture and other contaminants with a clean brush, or a soft, lint-free cloth. Do NOT use objects that could damage the tool.
- Make certain all pins, pivot points, and bearing surfaces are protected with a THIN coat of any good SAE No. 20 motor oil. Do NOT oil excessively, a thin oil film is sufficient!
- Close the tool's shank when the tool is not in use. This prevents something from getting between the dies. Keep the tool in a dry, clean environment.

## V

### **Guarantee**

This tool must be used exclusively for the purposes of crimping. HARTING tools are made of high quality material. All parts are designed and tested for the maximum working life.

HARTING provides a one year warranty on durability due to endurance tests and other tests concerning functionality and on the basis of careful delivery control granted. If material faults occur during this period, the tool will be repaired or replaced free of charge. This does not apply to material faults and a lack of functionality as a result of carelessness or mishandling.

## 9.5 Operating instructions for crimp tool 09 99 000 0377

Using the crimp tool 09 99 000 0377, turned HARTING Han® C male and female contacts with cross-sections of 6 mm<sup>2</sup> (AWG 10) and 10 mm<sup>2</sup> (AWG 8) can be processed. To process these contacts, the crimp tool is pre-fitted with a turnable locator which enables simple and secure handling.

### Included in delivery:

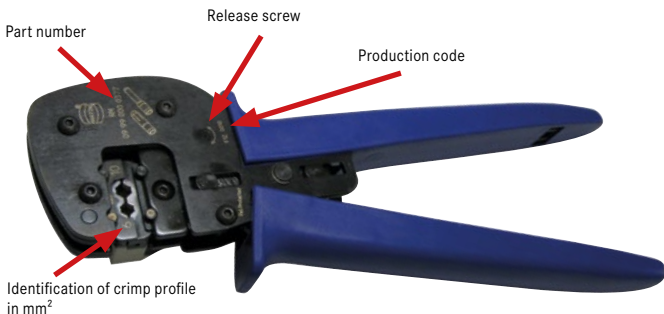
- HARTING crimp tool (incl. mounted locator)
- Operating instructions

The following table shows which contacts/wire gauges can be processed with the crimp tool:

*Wire gauges/stripping lengths to be processed*

Series	Wire cross-section (mm <sup>2</sup> )	Wire gauge (AWG)	Stripping length (mm)
Han® C	6.0	10	9.5
Han® C	10.0	8	15.0*
* Stripping length = 15.0 mm for cable ≥ 5.0 mm Stripping length = 18.0 mm for cable ≥ 6.4 mm			

### Structure of the tool



### Crimp profiles

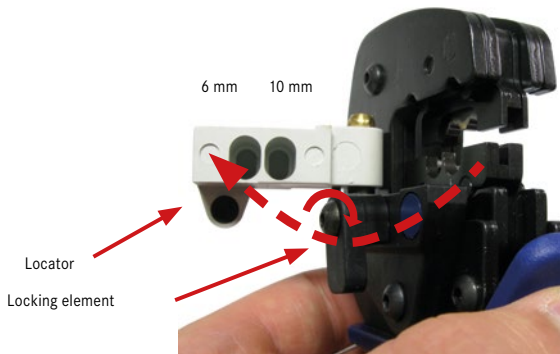
- ① Wire gauge 6.0 mm<sup>2</sup> (AWG 10)      ⇒ Han® C
- ② Wire gauge 10.0 mm<sup>2</sup> (AWG 8)      ⇒ Han® C

### Locator

The locator ensures that the crimp contact is always processed in the correct position (crimp zone).

The locator can be removed to process special contacts. To do this, turn the locking element downward and the locator to the left.

V



### Crimping process

1. Insert the crimp contact into the crimp profile intended. The locator automatically positions the crimp contact in the proper crimping position.
2. Press the tool's handles together gently to fix the crimp contact into position.
  - ① Wire gauge 6.0 mm<sup>2</sup> (AWG 10)      ⇒ Han® C
  - ② Wire gauge 10.0 mm<sup>2</sup> (AWG 8)      ⇒ Han® C
3. Insert the properly stripped stranded wire into the contact and make the crimp by squeezing the tool's handles together until the tool opens again by itself.
4. Remove the crimped contact

### Note: Check the quality of the crimp!

*You should visually inspect each crimp after it has been completed.*

### Ratchet mechanism

In order to ensure a constant crimp quality for all contacts the crimp tool is equipped with a releasable safety catch.

- The hand crimp tool can only be used after it has been opened completely.
- This prevents the tool being opened prematurely once the crimping process has been started.

### Early release

In the event of an operational error, it is possible to release the crimp tool before it has completed the crimp.

The following procedure must be observed here:

1. Remove the pressure off the lock unit by pressing gently on the handle.
2. Move the release screw (located above the production codes) to left or right, until the tool releases the contact. This prevents damage in cases where the crimp contact is inserted incorrectly in the crimp profile.

### CAUTION!

*Do not use force to open and shut the crimp tool.*

*Lubricate all moving parts when needed.*

*Pull-out forces of crimp connections according to DIN IEC 60 352-2, A2*

Cross-section		Pull-out force	Han® contacts
mm <sup>2</sup>	AWG	N	
6.0	10	360	C
10.0	8	380	C

**When the HARTING crimp tool is used correctly, the required pull-out forces comply with DIN IEC 60 352-2 A2.**

## 9.6 Crimp tool for D-Sub reel-packaged contacts 09 99 000 0169

### 1. Application field

The crimp tool is designed for crimping of D-Sub connectors. These are supplied in carrier strips of approx. 500 contacts per roll. The roll holder, indexing unit and two crimp profiles ensure easy handling with the best crimp result.

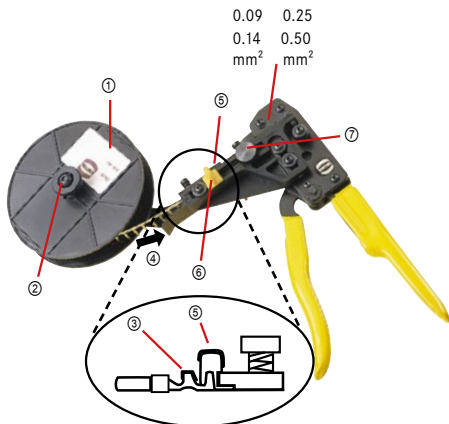
- Crimp profile 0.08 – 0.20 mm<sup>2</sup>
- Crimp profile 0.20 – 0.56 mm<sup>2</sup>

Each crimp profile crimps the contacts onto the conductors of the wire and the insulation in one step. After the crimping process, the contact is automatically cut from the carrier strip. The wire then is easily removed from the tool with a successful crimp installed onto the wire.

### 2. Indexing unit

The contact strip with the indexing unit moves into the correct position and is terminated as follows:

1. Assemble the contact roll ① on the roll holder ② holding it in place with the knurled nut ③. The contacts point towards the roll holder!
2. Close the tool until the ratchet lock releases.
3. Insert the contact strips ④ in the direction of the arrow, between the indexing unit and the retaining plate so that the indexing unit is guided fully to the end of the retaining plate between the wire crimp and insulation crimp.
4. Index the contact strip forward ⑦.



### 3. Adjustment of Indexing Unit

You must adjust the indexing unit before you process contacts in the 1<sup>st</sup> or 2<sup>nd</sup> crimping profile.

1. Undo the knurled nut.
2. Move the Indexing Unit to the left or to the right.
3. Tighten up the knurled nut again!
4. Check to see if the contact is in the middle of the respective crimp profile.



#### 4. Crimping

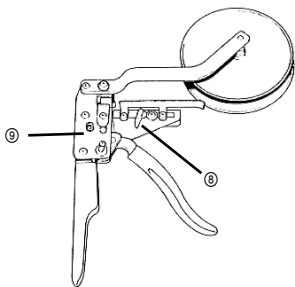
1. Ensure that the contact is in the middle of the crimp profile after the indexing.
2. Close the tool to the first detent.
3. Slide the wire into the contact.
4. Close the manual crimper completely until the safety ratchet allows the tool to be opened.
5. Remove the crimped contact.

#### Note: Remove the empty carrier strip!

*Regularly break the empty carrier strip behind the bending plate ①, so that the carrier strip does not interfere with handling of the tool.*

#### 5. Change the contacts

1. Release the red release lever ⑧ on the indexing unit in direction "Release" and hold it there.
2. Pull-out the contact roll away from the indexing unit towards the roll ①.
3. Remove the contact roll.
4. Load the indexing unit as stated in paragraph 3.



#### 6. Safety ratchet

The hand crimp tool can only be used after it has been opened completely. Each crimp process has to be done fully, before the tool can be opened again. This guaranties a good quality crimp each time.

#### Early Release

It is possible to release the tool early:

1. Push the tool handles slightly together.
2. Release the safety lock ⑥ on the rear of the tool by turning it anticlockwise.
3. Open the tool handles.

#### 7. Maintenance

Remove any existing material and dirt and clean the crimp zone regularly. Check the tool to ensure that the profile closes correctly, clean moving parts and oil them lightly (machine oil SAE 20). It is only permitted to have damage repaired by authorized personnel!

## 9.7 HARTING crimp tool 09 99 000 0620 for stamped contacts BC and FC according to DIN 41 612

### Note:

*Only use the crimp tool for crimping!*

*Only use HARTING crimp inserts!*

*Protect the crimp tool from dust and moisture!*



V The base tool 09 99 000 0620 can be provided with the following crimp insert sets:



Crimping die Set no.	For individual contacts	Cross-section range [mm <sup>2</sup> ]	Insulation Ø [mm]
09 99 000 0621	0902 000 .... BC	0.09 – 0.50	0.7 – 1.5
09 99 000 0621	0906 000 ...4 FC 1	0.09 – 0.25	0.7 – 1.5
09 99 000 0622	0906 000 ...1 FC 2	0.14 – 0.56	0.8 – 2.0
09 99 000 0623	0906 000 ...2 FC 3	0.50 – 1.50	1.6 – 2.8

FC contacts have an identification marking on the back.

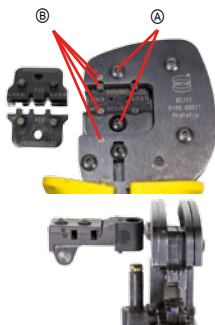
The locators are part of the respective sets, but can be ordered separately:



09 99 000 0630	locator <b>BC</b>	included in	09 99 000 0621	Crimp set BC/FC 1
09 99 000 0631	locator <b>FC1</b>		09 99 000 0621	Crimp set BC/FC 1

### Inserting the crimp sets:

1	Unscrew the fixing screw <b>A</b> - crimp tool closed
2	Then release and open the crimp tool.
3	Remove inserts, the upper insert first.
4	Insert the new inserts - the colour marking must match the markings <b>B</b> on the tool (the lower insert first).
5	Secure the inserts with the fixing screws: ISKA M4x18 (upper); ISKA M4x9 (lower)
6	Plug the locator from the top so that the contact holder points in the direction of the tool when in a closed state.



## Locking mechanism

In order to ensure a constant crimp quality for all contacts the crimp tool is equipped with a releasable safety catch.

- The hand crimp tool can only be used after it has been opened completely.
- This prevents the tool being opened prematurely once the crimping process has started.



## Early crimp release

The crimp tool is unlocked by pressing

1. the tool together slightly
2. turning the screw as shown in the direction of the arrow (see red arrow). Then the crimp tool can be completely opened.

### Note:

*Do not use force to open or close the crimp tool.*

## Crimping

1. Fold out the locator.
2. Insert the individual contact into the locator (A). Make sure you use the right chamber!
3. Fold in the locator.
4. Close the tool up until the contact is securely held (B).
5. Insert the wire into the contact.
6. Crimp the contact until the tool releases.
7. Remove the crimped contact.



## Maintenance

- Clean the crimp tool of dust and oil!
- Protect the crimp tool from dust and moisture!

*Pull-out forces of crimped contacts is in accordance with IEC 60352, Part 2.*

Cross-section	Breaking force of the stranded wire
0.09 – 0.25 mm <sup>2</sup>	75 %
0.38 – 0.57 mm <sup>2</sup>	65 %
0.75 – 1.50 mm <sup>2</sup>	60 %

**Note:** *We reserve the right to modify designs in order to improve quality, keep pace with technological advancement or meet particular requirements in production.*

## 9.8 HARTING service crimp tool 09 99 000 0191 for FC individual contacts

### Service crimp tool Gds A-F/FC

0.14 – 1.5 mm<sup>2</sup>

AWG 26 - AWG 16



### Ratchet Mechanism

In order to ensure a constant crimp quality for all contacts the crimp tool is equipped with a releasable safety catch.

- The hand crimp tool can only be used after it has been opened completely.
- This prevents the tool being opened prematurely once the crimping process has started.

### Early release

It is possible to perform an early release of the safety ratchet in case of a faulty crimping. Proceed as follows:

1. Remove the pressure off the crimp tool by pressing gently on the handle.
2. Operate the release lever in the direction of the tool head (see sketch).
3. The crimping die is now protected in the event that the contact does not lie correctly in the crimp profile.

### Note:

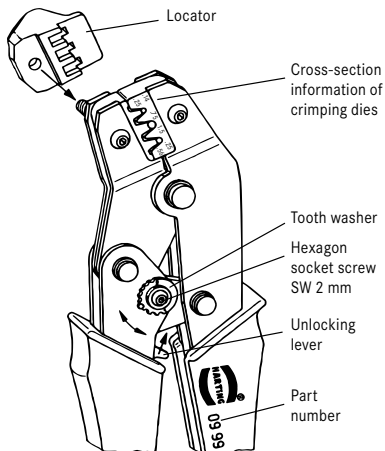
*Do not open or close the tool by force, oil moving parts every week!*

### Fixing the locator

The supplied locator must be fastened on the upper part of the tool head (see sketch).

### Crimping process

1. Insert the contact into the locator.
2. Hold the contact between the slightly closed crimping dies.



3. Insert the stripped stranded wire into the contact.
4. Crimp until the tool opens again.
5. Remove the crimped contact.

### Adjustment of the crimping depth

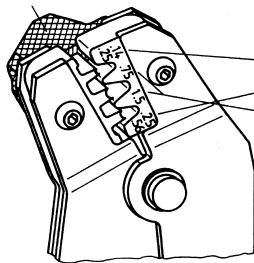
If after prolonged use the crimp tensile strength in the connection between the stranded wire and the barrel of the contact is no longer sufficient, the pressure of the dies can be increased by adjusting the eccentric ratchet plate.

1. Loosen by two turns of the hexagonal socket screw with a hexagon screwdriver (SW 2 mm).
2. Lift the toothed spring washer and turn it by hand counter clockwise in direction "9". Tighten the hexagon socket screw.

*Pull-out force of the crimped wire in the connection is in accordance with DIN 41 611, Part 3, and IEC 60352-2*

Cross-section		Breaking force of the stranded wire
mm <sup>2</sup>	AWG	
≤ 0.3	≤ 24	75 %
> 0.3 - 0.6	> 24 - 20	65 %
> 0.6 - 1.5	> 20 - 16	60 %

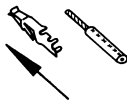
Locator



Cross-section	
mm <sup>2</sup>	AWG
0.14-0.25	26-24
0.25-0.56	24-20
0.75-1.5	18-16

#### Note:

*We reserve the right to modify designs. To improve quality, we keep pace with technological advancement or meet particular requirements in production.*



## 10. Assembly and disassembly instructions

### 10.1 Assembly of contacts

After crimping the *stranded wire* to the contact with a manual tool or a crimping machine, the contacts are then inserted and locked into the contact chambers with the tool from the termination side. A mounting tool is required with *stranded wires* under  $0.5 \text{ mm}^2$  (see Table V-17 and Table V-18, p. 100).

V




		
<i>Insert contact with crimped wire into the contact chamber on the termination side.</i>	<i>Insert plug contact until it stops, until the contact clicks audibly.</i>	<i>Check that the catch is firmly seated by lightly pulling on the stranded wires.</i>

Table V-17: Assembly tools for turned contacts for industrial connectors

Type	Part number
D-Sub	09 99 000 0171
Han D <sup>®</sup>	09 99 000 0059
Han E <sup>®</sup>	09 99 000 0059
Han <sup>®</sup> C	omitted




Table V-18: Assembly tools for stamped contacts for electronic connectors

Type	Part number
FC1	09 99 000 0088
FC2	09 99 000 0088
FC3	09 99 000 0088
BC	09 99 000 0100
har-bus <sup>®</sup> 64	omitted




## 10.2 Removal of contacts

If you want to remove a crimp contact, you need a tool that is matched to the type of contact (see Table V-19 and Table V-20, p. 102). Using the appropriate tools, HARTING contacts can be gently and safely removed from the contact chamber. It is strongly discouraged to disassemble with a tool that is not specially intended for the purpose, e.g. a screwdriver. Using an unsuitable tool, the danger of damaging the contact and contact chamber is higher.

### Han D® contacts

		
<p><i>Insert the tool from the mating side via the contact to the stop.</i></p>	<p><i>Press the removal tool into the contact chamber, and the retaining spring is also released on contact.</i></p>	<p><i>Pull-out the contact at the crimped wire to the back.</i></p>

### Han E® contacts

		
<p><i>Insert the tool from the termination side next to the stranded wire over the recess intended for this (see arrow) into the contact chamber.</i></p>	<p><i>Press the tool in to the stop. This opens the contact chamber.</i></p>	<p><i>Pull the contact at the crimped stranded wire together with the tool out of the contact chamber.</i></p>

V

## Han® C contacts

The removal of the Han® C contacts is the same as the removal of the Han E® contacts.

*Table V-19: Removal tools for turned contacts for industrial connectors*

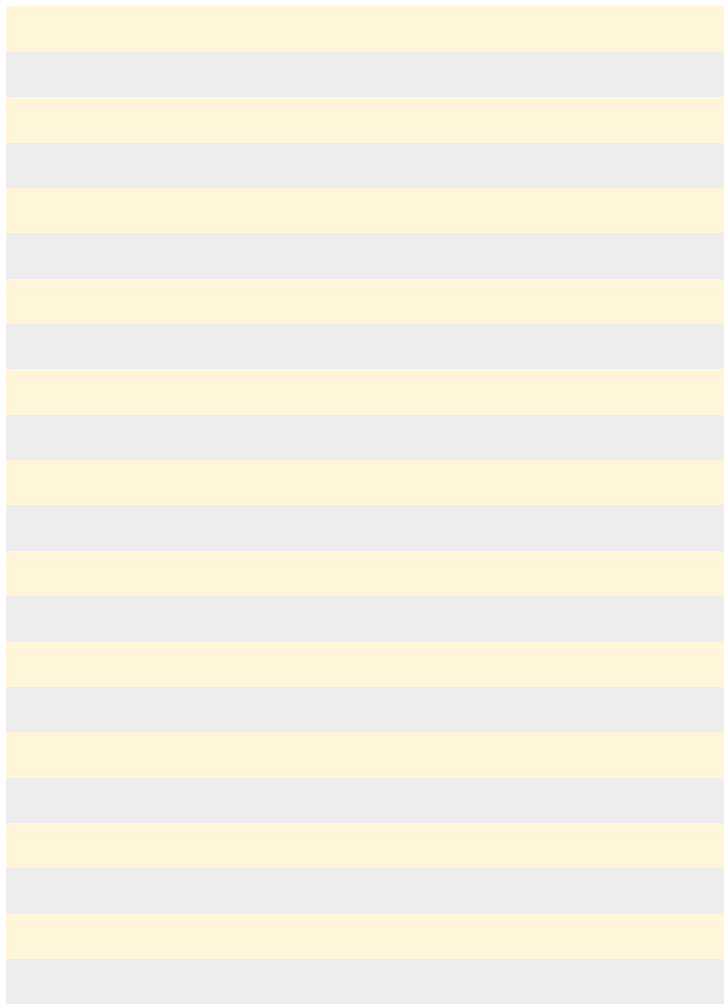
Type	Part number
D-Sub	09 99 000 0171
Han D®	09 99 000 0012
Han E®	09 99 000 0319
Han® C	09 99 000 0305/0381

*Table V-20: Removal tools for stamped contacts for electronic connectors*

Type	Part number
FC1	09 99 000 0087
FC2	09 99 000 0087
FC3	09 99 000 0087
BC	09 99 000 0101
har-bus® 64	02 99 000 0013



## Notes



V



## Notes

V

A large rectangular area filled with alternating horizontal stripes of light yellow and light grey, intended for taking notes.

---

## VI. Cage-clamp termination

### Table of Contents

1. Introduction .....	106
2. Features.....	107
2.1 Cage-clamp termination technology: general information.....	107
2.2 Cage-clamp combined with press termination technique (Han® ES Press).....	107
3. Cage-clamp terminals in HARTING products.....	108
4. Assembling the cable-clamp terminals.....	109
4.1 Standard cage-clamp contacts .....	109
4.2 Han® ES Press .....	111
4.3 Using ferrules.....	113
4.4 Possible assembly errors .....	113
5. Standards and guidelines.....	114

## 1. Introduction

In cage-clamp termination technology, a spring terminal secures the end of the wire in the insert. This cage-clamp establishes an electrically conductive connection with the contact. HARTING offers two types of cage-clamp contacts. The first variant comes delivered with the cage-clamp closed. A screwdriver or HARTING assembly tool is used to open the terminal so that the wire can be inserted. The second variant, Han<sup>®</sup> ES Press, is delivered with the actuator already open.

VI

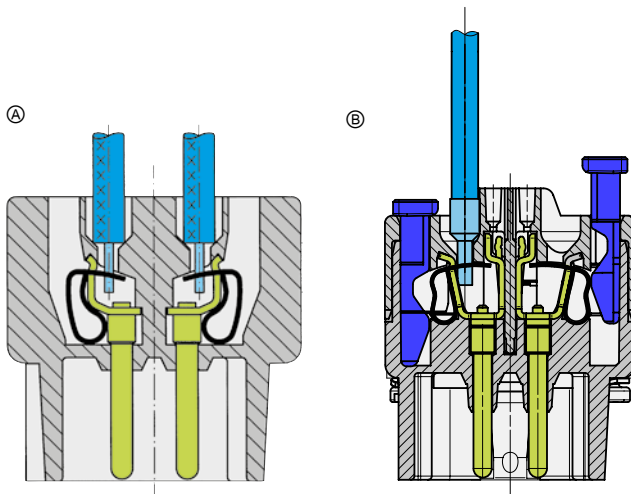


Fig. VI-1: Wire termination used by a standard cage-clamp (A) and the Han ES Press (B)

## 2. Features

### 2.1 Cage-clamp termination technology: general information

- Connects wires (with or without ferrules) with cross-sections from 0.14 mm<sup>2</sup> to 2.5 mm<sup>2</sup>
- High current carrying capacity
- Consistently low potential drop at the termination point.
- Spring exerts constant pressure on the wire so no maintenance is required
- Clamping force increases as the wire diameter increases
- Saves time compared to the screw terminal technique
- Easy to handle and less tool work
- Reduced material and labour costs, since assembly possible without ferrules or pin-end connectors, and no special processing of the wire end is needed.
- Connection is resistant to shock and vibration, in compliance with DIN EN 50467
- Can be tested directly at the termination point (when using the Han<sup>®</sup> ESS)

VI

### 2.2 Cage-clamp combined with press termination technique (Han<sup>®</sup> ES Press)

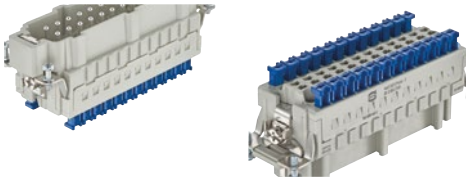
- Rapid termination technique based on cage-clamp technology requires no tools
- Easy to handle with quicker processing times than other termination techniques
- Very convenient to work with:
  - It is quick and simple to connect the wire directly, since the terminal actuators are delivered open
  - No force is needed to insert the wire into the contact chamber
  - Actuator snaps in with an audible and tactile click
  - The actuator can be quickly and easily opened using a conventional screwdriver when you need to remove the wire
- Connects wire (with or without ferrules) with cross-sections from 0.14 mm<sup>2</sup> to 2.5 mm<sup>2</sup>
- Plug-in bridges can optionally be used to bridge contacts and distribute potentials (e.g. when connecting motors, sensors, etc.)

### 3. Cage-clamp terminals in HARTING products

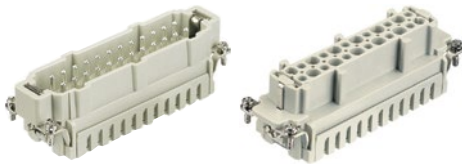
The cage-clamp contacts are being used in inserts for the following HARTING product series: Han® ES Press, Han® ES, Han® ESS, Han® HvES, Han-Modular®, Han® ES AV, DIN rails in size H, Industrial Ethernet products, as well as in other customized solutions.

Figure VI-2: Han® products with cage-clamp contacts

VI



- Han® ES Press: quick, tool-free connection



- Han® ES: no special tools are required



- Han® ESS: two connections per contact



- Han® ES Module; cage-clamp termination Han-Modular®

- Han® ES AV: quick connections with angled shape

## 4. Assembling the cable-clamp terminals

### 4.1 Standard cage-clamp contacts

Before starting the assembly, note the markings for the wire inlets and for the screwdriver on the inserts. The rectangular slot is used to hold the assembly tool that opens the termination point. Use the HARTING assembly tool listed in Table VI-1 or a screwdriver in accordance with Table VI-2, p. 110. The round opening is used to hold the wire that is being connected.

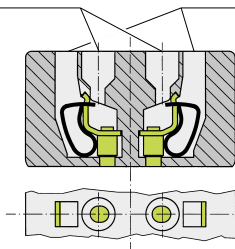
VI

#### Note:

Only one wire per termination point is permitted!\*

Termination point

Slot for screwdriver



\* Each termination point is, in principle, only suited to hold a single wire. However, under certain conditions, other solutions are also possible. When required, two or more wires may be contacted per termination point; contact HARTING Technical Support first for more information.

Figure VI-3: Structure of termination point with cage-clamp

Table VI-1: Assembly tools for use with the Han® ES / ESS and ES Module series

Assembly tool	09 99 000 0367	
---------------	----------------	--

#### Note:

An effective and durable spring clamp connection requires that the wire is properly stripped. The correct stripping lengths for Han® ES, Han® ESS and DIN 41 612 contacts are specified in Table VI-1, p. 109.

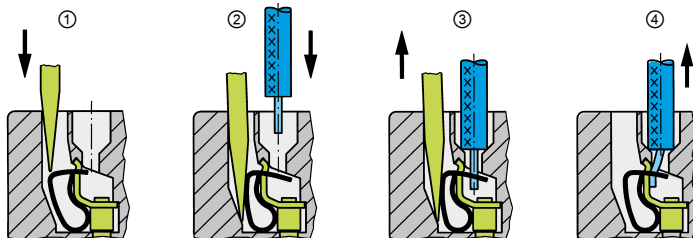
Table VI-2: Stripping lengths and cross-sections

Insert	Max. cross-section		Stripping length (mm)	Recommended screwdriver width (mm)
	mm <sup>2</sup>	AWG		
Han® ES, Han® HvES, Han® ES AV, Han® ES Module	0.14 - 2.5	26 - 14	7 - 9	3.5 x 0.5
Han® ESS	0.14 - 2.5	26 - 14	9 - 11	3.5 x 0.5
DIN 41 612 size H 15	0.14 - 1.5	26 - 16	4 - 7	2.5 x 0.4

VI

If required, the stripped stranded wire can also be fitted with a ferrule (refer to Chapter 4.3, Using ferrules, p. 113).

### Assembly



① ② ③ Screwdriver width: 3.5 x 0.5 mm

④ = Gentle test pull!

- ① Strip the wire in accordance with DIN EN 60 352, part 7. Refer to Table IV-2, p. 32, for stripping lengths. Insert the screwdriver or assembly tool in the appropriate slot in order to open the contact chamber.
- ② Insert the stripped wire into the appropriate slot.
- ③ Remove the screwdriver/assembly tool from the slot.
- ④ Pull gently to make sure the connection is secure.

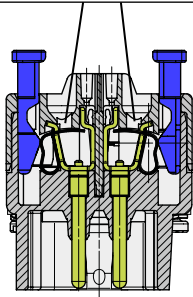


## 4.2 Han® ES Press

The circular openings in the insert are used to hold the wire that is being connected. Note that there are two rows of rectangular holes (intended for plug-in jumpers) located between the contact openings of the Han® ES Press insert.

### Note:

*Only one wire per termination point!\**



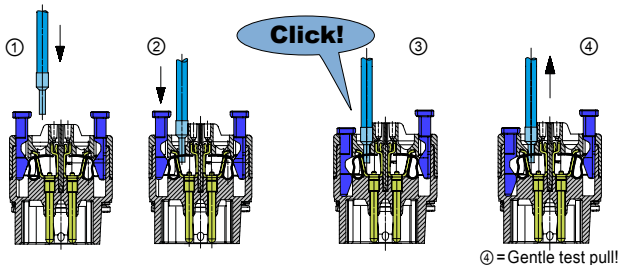
\* Each termination point is, in principle, only suited to hold a single wire. However, under certain conditions, other solutions are also possible. When required, two or more wires may be contacted per termination point; contact HARTING Technical Support first for more information.

Figure VI-4: Structure and arrangement of termination points with Han® ES Press

### Note:

An effective and durable spring clamp connection requires that the wire is properly stripped. The correct stripping lengths for the Han® ES Press contacts are specified in Table VI-3, p. 112.

### Assembly



- ① Insert the stripped wire (according to Table VI-3) into the Han® ES Press contact chamber. Do not use force.
- ② Press the actuator with your hand or using a screwdriver in the contact chamber.
- ③ The actuator will snap in with an audible click.
- ④ Pull gently to check if the wire is securely attached.
- ⑤ Before processing further, make sure that all actuators are closed.

## VI

Table VI-3: Stripping lengths and wire cross-sections for Han® ES Press

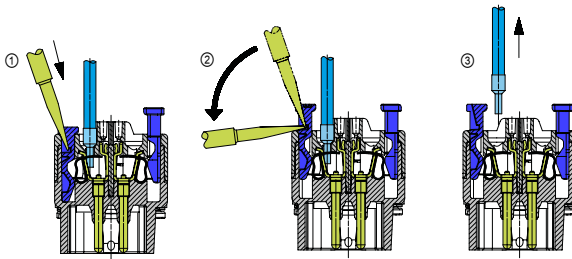
Insert	Max. cross-section		Stripping length (mm)	Recommended screwdriver width (mm)
	mm <sup>2</sup>	AWG		
Han® ES Press	0.14 - 2.5	26 - 14	9 - 11	2.5 x 0.5

If required, the stripped wire can also be fitted with a ferrule.

## Removal

### Note:

To remove the wire, use a conventional screwdriver with a blade of 0.5 x 2.5 mm.



- ① Insert the screwdriver gently and at an angle onto the actuator.
- ② Use the screwdriver as a lever to gently press down.
- ③ Remove the wire from the contact chamber when the actuator is in its upper position (the cage-clamp is opened).

### 4.3 Using ferrules

Figures VI-4 and VI-5 show the cage-clamp connections. The micro-sections show that this termination method delivers equally high quality connections both for prepared wires (with ferrules already crimped on) and for unprepared (only stripped) wires.

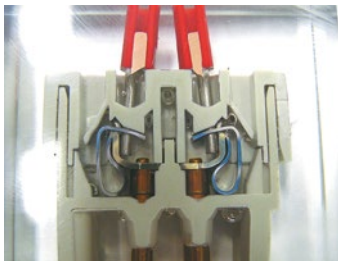


Figure VI-4: Termination with ferrule crimped on

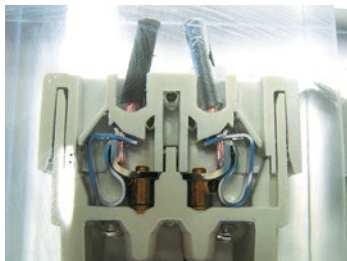


Figure VI-5: Termination with stripped stranded wire

VI

### 4.4 Possible assembly errors

**Note:**

*Errors may occur if you do not follow the assembly instructions accompanying the inserts and cage-clamp termination modules!*

The connection between the wire and the contact must be very carefully established so that the resulting cage-clamp and connector function properly and are standard-compliant. In this respect, the cage-clamp is no different than other wire termination types. The following preventable errors may occur when making a cage-clamp termination:

- The stranded wire is improperly inserted into the contact chamber, or the wire is inserted into the wrong slot
- The stripping tool has not been set properly
- The stripping tool blade is damaged
- The wrong assembly or removal tool is being used
- The wire has the wrong cross-section:  $\varnothing < 0.14 \text{ mm}^2$  or  $\varnothing > 2.5 \text{ mm}^2$

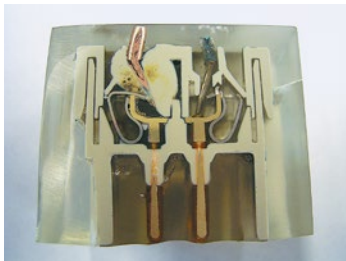


Figure VI-6: The consequences of improper assembly (shown here on the Han® ES)



Figure VI-7: The consequences of improper assembly (shown here on the Han® ES), close-up

In the example shown by Figures VI-6 and VI-7, the contact chamber was opened using an improper tool and the spring terminal was damaged. The connector burned as a result.

## 5. Standards and guidelines

The requirements for making and testing cage-clamp contacts are specified in the DIN EN 60 999 and DIN EN 60 352-7 standards. A key factor is the *tensile strength*: some of the required values are shown in Table VI-4.

Table VI-4: Minimum tensile strength

Tensile strength of connections (DIN EN 60 352-7, Tab. 1)							
Wire cross-section, mm <sup>2</sup>	0,22	0,34	0,5	0,75	1,0	1,5	2,5
Min. tensile strength, in N*	10	15	20	30	35	40	50

\* 10 N corresponds to a force of approx. 1 kg.

---

## VII. Han-Quick Lock®

### Table of Contents

1. Radial cage-clamp.....	116
2. Cage-clamp terminal and Han-Quick Lock® .....	116
3. Useable cable types.....	117
4. Advantages .....	118
5. Application areas .....	118
6. Normative requirements .....	119
7. Technical details .....	119
7.1 Stripping lengths, cable cross-sections.....	119
7.2 Micrographs.....	120
8. Series with Han-Quick Lock® .....	121
9. Suitable tools .....	123
10. Assembly instructions.....	123
10.1 Assembly .....	123
10.2 Removal .....	124

## 1. Radial cage-clamp



To allow for quick assembly of connectors in the field, HARTING has developed the radial cage-clamp technology under the name Han-Quick Lock®. This termination technique combines the reliability and ease of use of the standard cage-clamp termination with the minimal space requirement of the crimp technology. It is the only termination technique that can be pre-assembled as well as assembled on-site achieving a contact density comparable to crimp termination.

VII

Features:

- Quick, simple and robust termination technology
- Can be assembled on-site with a screwdriver
- Resistant to shock and vibration just like a standard cage-clamp termination
- Mating compatibility with many inserts and modules of the Han® connector series

## 2. Cage-clamp terminal and Han-Quick Lock®

Figure VII-1 describes the core of the Han-Quick Lock® termination. It is easy to see here what makes the termination technology reliable: The spring (round clamp spring) encloses the stranded wire and clamps it *radially*.

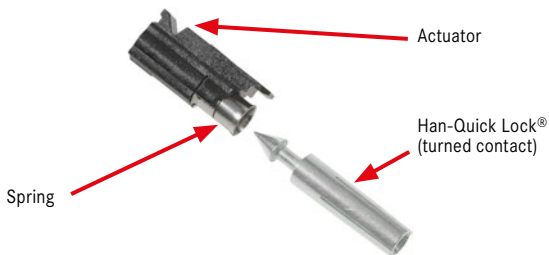


Figure VII-1: Actuator and radial clamp of the Han-Quick Lock®

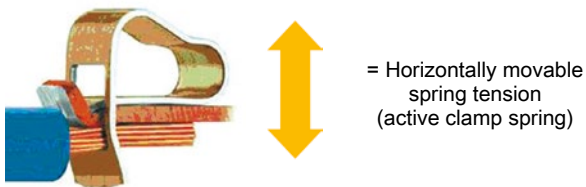


Figure VII-2: Cage-clamp termination



Figure VII-3: Han-Quick Lock® contact

Figures VII-2 and VII-3 show the different directions of the spring clamp of the cage-clamp termination and Han-Quick Lock® termination technology.

### 3. Useable cable types

The termination technology allows the use of fine-stranded wires according to VDE 0295 class 5 (see chapter IV, Table IV-6), which corresponds to standard stranded wires.

The following is *not* to be processed:

- Solid wire



- Stranded wire with only a few single strands



- Twisted wire



## 4. Advantages

- Time saving: a time saving of 20% is achieved with the use of Han-Quick Lock® compared to the traditional screw termination technique.
- Vibration resistance: stranded wires terminated with Han-Quick Lock® meet the high demands of the transport industry (shock and vibration test according to DIN EN 61 373).
- Wire retention force: The required minimum values as specified in DIN EN 60 352-7 have been greatly exceeded (refer to Figure VII-4).
- Contact resistance: Results from the climatic test and the multi-component industrial gas test show that the contact resistance of the Han-Quick Lock® terminations is significantly below the max. permitted values specified in DIN EN 60 352-7.

## 5. Application areas

Connectors with Han-Quick Lock® contacts are used in a wide variety of electronic and electrical applications. The degree of protection of the housing complies with international standard IEC 60 529 and IEC 60529. The application areas include:

- Energy installations
- Industrial instrumentation
- Robotics
- Conveyor equipment
- Chemical installations
- Electrical cabinet manufacturers
- Machine controls
- Injection moulding machines



## 6. Normative requirements

The conditions for the set-up and testing of radial clamps are specified in the standard DIN EN 60 352-7 similar to the standard cage-clamp.

### Wire pull-out forces

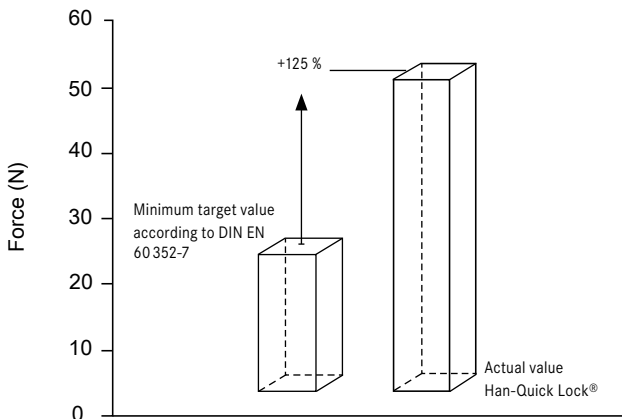


Figure VII-4: Wire pull-out forces with cable cross-section  $0.5 \text{ mm}^2$

VII

## 7. Technical details

### 7.1 Stripping lengths, cable cross-sections

Table VII-1: Technical characteristics of Han-Quick Lock® termination technology

Max. cable diameter	3.6 mm
Terminal cross-section	0.25 – 1.5 mm <sup>2</sup> / AWG 23 – 16 (black slide actuator) 0.5 – 2.5 mm <sup>2</sup> / AWG 20 – 14 (blue slide actuator)
Stripping length	10 mm
Can be rewired without damage	≤ 10 contact assemblies

## 7.2 Micrographs

X-ray images allow a view of the interior of the Han-Quick Lock® termination technology: Figure 1 shows the spring on the cone, Figure 2 shows a close-up of the spring, Figure 3 shows the interaction between stranded wires, cone and spring (see Figure VII-5).



Figure VII-5: X-ray images of Han-Quick Lock®

## 8. Series with Han-Quick Lock®

Table VII-2: Connector series with Han-Quick Lock® termination technology

Series	Power (0.5 - 2.5 mm <sup>2</sup> )		Signal (0.25 - 1.5 mm <sup>2</sup> )	
	Article no.	Product	Article no.	Product
Han® PushPull	09352320401	Han® PushPull Power 4/0-F Metal QL	09352340401	Han® PushPull Power 4/0-F Metal QL 1.5 mm <sup>2</sup>
	09352320311	Han® PushPull PFT Metal rectangular QL power	09352340311	Han® PushPull PFT Metal rectangular QL power 1.5 mm <sup>2</sup>
	09352320423	Han® PushPull Power 4/0-F QL AWG20-14	09352340421	Han® PushPull Power 4/0-F Plastic QL 1.5 mm <sup>2</sup>
	09352320331	Han® PushPull PFT Plastic rectangular QL power	09352340331	Han® PushPull PFT Plastic rectangular QL power 1.5 mm <sup>2</sup>
Han A®	09200032733	Han® 3A-F-QL	09200032734	Han® 3A-F-QL 1.5 mm <sup>2</sup>
	09200032633	Han® 3A-M-QL	09200032634	Han® 3A-M-QL 1.5 mm <sup>2</sup>
	09200042733	Han® 4A-F-QL	09200042734	Han® 4A-F-QL 1.5 mm <sup>2</sup>
	09200042633	Han® 4A-M-QL	09200042634	Han® 4A-M-QL 1.5 mm <sup>2</sup>
Han D®			09210072732	Han® 7D-F Quick Lock 0.3 - 1.5 mm <sup>2</sup>
			09210072632	Han® 7D-M Quick Lock 0.3 - 1.5 mm <sup>2</sup>
			09360082732	Han® 8D-F Quick Lock 0.3 - 1.5 mm <sup>2</sup>
			09360082632	Han® 8D-M Quick Lock 0.3 - 1.5 mm <sup>2</sup>

Series	Power (0.5 - 2.5 mm <sup>2</sup> )		Signal (0.25 - 1.5 mm <sup>2</sup> )	
	Article no.	Product	Article no.	Product
Han® Q			09120062762	Han® Q4/2 F-AS-QL 2.5-6 mm <sup>2</sup>
			09120062662	Han® Q4/2-M-AS-QL 2.5-6 mm <sup>2</sup>
			09120062763	Han® Q4/2 F-AS-QL
			09120062663	Han® Q4/2-M-AS-QL
	09120052733	Han® Q5/0-F-QL	09120052734	Han® Q5/0-F-QL 1.5 mm <sup>2</sup>
	09120052633	Han® Q5/0-M-QL	09120052634	Han® Q5/0-M-QL 1.5 mm <sup>2</sup>
	09120082733	Han® Q8/0-F-QL	09120082734	Han® Q8/0-F-QL 1.5 mm <sup>2</sup>
	09120082633	Han® Q8/0-M-QL	09120082634	Han® Q8/0-M-QL 1.5 mm <sup>2</sup>
			09120123101	Han® Q 12-F-QL
			09120123001	Han® Q 12-M-QL
Han-Modular®	09140062733	Han® E Quick-Lock Module, female	09140122732	Han DD® Quick Lock Module, female
	09140062633	Han® E Quick-Lock Module, male	09140122632	Han DD® Quick Lock Module, male
	09140082733	Han® EE Quick Lock Module, female	09140122734	Han DD® Quick Lock Module, male Au
	09140082633	Han® EE Quick Lock Module, male	09140122634	Han DD® Quick Lock Module, male Au
			09140082734	Han® EE Quick Lock Module, female 1.5 mm <sup>2</sup>
			09140082634	Han® EE Quick Lock Module, male 1.5 mm <sup>2</sup>
Han-Yellock®	11051052633	Han-Yellock® Module-M-QL 20A	11051052634	Han-Yellock® male carrier QL 10A, 1.5 mm <sup>2</sup>

## 9. Suitable tools

Table VII-3: Suitable tool for Han-Quick Lock® termination technology

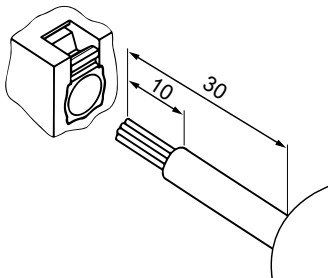
Screwdriver	0.4 x 2.5 mm
Screwdriver	0.5 x 3.0 mm

## 10. Assembly instructions

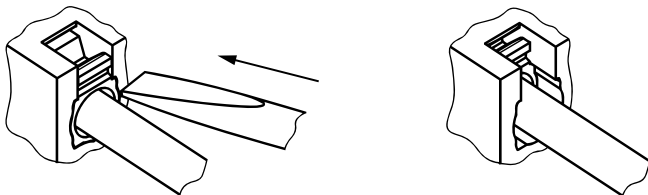
VII

### 10.1 Assembly

1. Remove the cable sheath and strip the *stranded wires*.



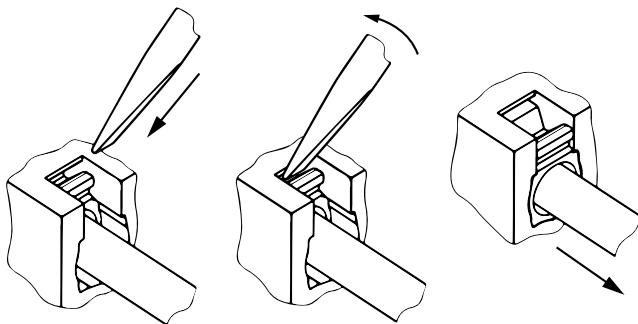
2. Push the *stranded wire* into the Han-Quick Lock® contact chamber and push the actuator in all the way using a screwdriver. Meanwhile, push the stranded wire further into the contact chamber!



## 10.2 Removal

Insert the screwdriver at an angle of 45° into the opening of the coloured actuator intended for this purpose and lever the actuator out. Then remove the *stranded wire* from the contact chamber.

VII

**Note:**

You can find a video film with assembly instructions for Han-Quick Lock® on the Internet under:

<http://www.harting.com/service/videos/video-presentationen/>

---

## VIII. Solder termination technology

### Table of Contents

1. Introduction .....	126
2. Soldering method.....	127
2.1 Wave soldering.....	127
2.2 Reflow soldering .....	128
3. Soldering bath temperatures for wave soldering.....	129
4. Solder .....	129
5. Soldering profiles.....	130
6. HARTING SMC/SMT .....	131
7. Standards .....	136
8. HARTING connector product range for soldering/SMC/SMT .....	139

## 1. Introduction

Soldering is a thermal process for firmly joining and bonding materials, whereby a liquid phase is produced by melting a solder (reflow soldering) or by diffusion at the interfaces (diffusion soldering). The melting point of the base metals is not reached (extract from DIN 8505).

### VIII

A distinction is made in soldering between soft-soldering and brazing. Soft-soldering refers to a temperature of up to 450°C. Above this, up to 900°C, the soldering process is referred to as brazing.

The components produced by HARTING are soft-soldered.

In the case of soldering, a non-detachable, firmly bonded connection is produced between the same (e.g. copper with copper) or different materials (e.g. copper with silver) using solder. The solder is an easily fusible metal alloy consisting mainly of tin and other metals such as copper or silver, and serves as a bonding material. The goal is a solid electrical connection between two metal components. The components produced by HARTING for solder termination technology on the PCB and on the cable side can be processed using all the established and recognized soldering processes. The different soldering processes are described below.

Further information on electronic assemblies are contained in IPC A 610. This directive lays down this general acceptance criterion. Publisher of the German translation is the Professional Electronic Design Association (FED).

Due to the environmentally hazardous properties and the associated risks to health, since 1 July 2006, lead (Pb) may no longer be used above certain concentrations in materials in the electronics field. The appropriate directive is the *RoHS 2011/65/EU (RoHS 2)* adopted by the EU. All HARTING products meet the RoHS 2 and are suitable for the higher soldering temperatures prescribed in it.



## 2. Soldering method

Common soldering methods include:

- wave soldering (flow soldering)
- reflow soldering

### 2.1 Wave soldering

Wave or flow soldering is a technology for implementing electronic circuits on printed circuit boards. The printed circuit board moves on a travelling transport system at a uniform speed through the soldering machine.

VIII

The assembled printed circuit board first passes through the flow soldering flux station (*spray or foam fluxer*). The pre-heating zone follows, in which the solvent contained in the fluxer is evaporated.

The pre-heating station is followed by the actual wave solder bath, in which the soldering operation is carried out. The tin solder is heated to above the melting point and continuously pumped over an edge in a molten (liquid) state, so that the flow (wave) necessary for soldering is generated. The printed circuit board is moved through this solder flow, so that the solder wave touches its underside. The tin solder can rise only by capillary action into the holes.

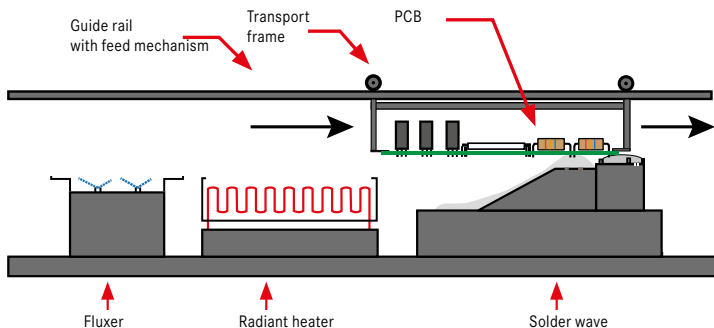


Figure VIII.-1: Principle of wave soldering

## 2.2 Reflow soldering

The term reflow soldering describes a soft-soldering process common in electrical engineering for soldering SMT and SMC components.

In the first step of reflow soldering, the (soft) solder is applied in the form of solder paste to the circuit board prior to assembly. There are several ways to apply the solder, for example, by stencil printing (screen printing), dispensers or solder preforms.

VIII

In the next step, the components are assembled: Since lead solder paste is sticky, the components adhere to it directly during assembly. When the solder melts, the assembled components are centered by the surface tension on the land pads.

### Conventional reflow soldering

With convection soldering and vacuum soldering, PCBs are soldered in continuous flow soldering passages. A conveyor system moves the part to be soldered through a furnace. The soldering process can be controlled by the dwell time in the various temperature zones.

Typically, the part to be soldered moves through four zones:

1. Heating zone
2. Activation zone of the flux (*fluxer*)
3. Soldering zone
4. Cooling zone

#### Convection soldering

It has been replaced by the convection soldering. Air is heated and passes through nozzles to the part to be soldered, whereby the heat is distributed uniformly.

#### Vacuum soldering

With vacuum soldering (free of voids and flux), it is physically only possible to transfer heat by radiation and by contact. Transferring heat by convection is not possible in a vacuum due to lack of a transmission medium. Therefore, vacuum soldering uses both the transfer of heat by contact (contact soldering) and the transfer of heat by radiation.

#### Vapour phase soldering (condensation soldering)

This soldering method comes relatively close to being the ideal soldering method. It is used for soldering SMT and SMD components, which are assembled in the solder paste.

SMT - Surface Mount Technology, describes a component only soldered on the surface using the reflow soldering process.

SMC - Surface Mount Compatible, describes a component which is soldered using the reflow method, but still has pins for fixing through the PCB.

A liquid is heated up to its boiling point and changes from the liquid aggregate state to a gaseous one. The resulting vapour does not get hotter than the boiling point of the liquid medium and spreads itself uniformly by its nature.

Therefore, all the solder joints have exactly the same preset correct soldering temperature, which is determined by the gas.

### 3. Soldering bath temperatures for wave soldering

Lead-free (*RoHS-compliant*) solders have a higher melting point and thus a higher processing temperature. These values to the respective alloys can be found in Table VIII-1.

Table VIII-1: Melting and processing temperatures of solder alloys

Alloy	Melting temperature [°C]	Processing temperature [°C]
Tin-silver (Sn96 Ag4)	221	265
Tin-copper (Sn99 Cu1)	227	270
Tin-silver-copper (Sn95.5 Ag3.8 Cu 0.71)	217	260

### 4. Solder

Soldering generally involves alloys of different metals. The melting point of the alloy is lower than that of the individual metals. Before soldering, the parts to be joined must be mechanically and chemically cleaned well. Flux removes the oxide layer on the metals and protect them against renewed oxidation. Because the tensile strength of the solder is lower than that of the materials to be joined, the solder layer should be as thin as possible for soldered connections.

Table VIII-2: Overview of soldering temperatures

Solder alloy	Melting point [°C]	Soldering temperature Standard reflow [°C]	Soldering temperature Vapour phase soldering [°C]	RoHS-compliant	Comment
Sn96 Ag4	221	approx. 245	230	Yes	can be processed using both methods
Sn99 Cu1	227	approx. 250	not reliably possible	Yes	can only be processed with higher temperatures
Sn 95.5 Ag 3.8 Cu 0.71	217	approx. 240	230	Yes	can be processed using both methods
Sn 69.5 Ag 3.0 Cu 0.5	217 – 221	approx. 240	230	Yes	can be processed using both methods
Sn60 Pb40	183 – 190	approx. 210	200	No	contains lead

**Note:**

Different alloys are used for different application areas. When making repairs, ensure that you use the same solder alloy as used during manufacture. Otherwise, a solder with a melting point that is too low can be created, so the assembly no longer has the required working life and/or the required operational safety.

## 5. Soldering profiles

A soldering profile shows the temperature profile during soldering as a function of time (temperature-time diagram). Solder profiles show how components can be safely processed during the soldering process.

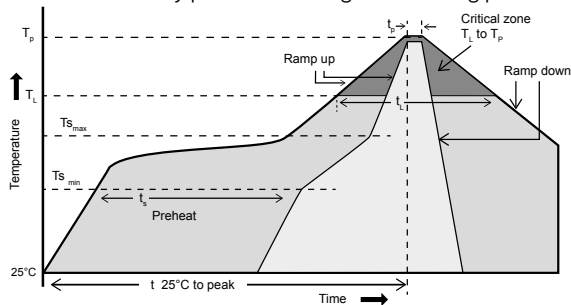


Figure VIII-2: Soldering profile measured on the component according to IPC-Jedec J-Std 020C

The peak temperature ( $T_p$ ) can be up to 260°C according to the JEDEC and the peak time ( $t_p$ ) can be up to 40 sec.

Figure VIII-3A shows a commonly used soldering profile in practice (for reflow soldering). The temperature profiles shown here and also the peak temperature are used today by most electronics manufacturers.

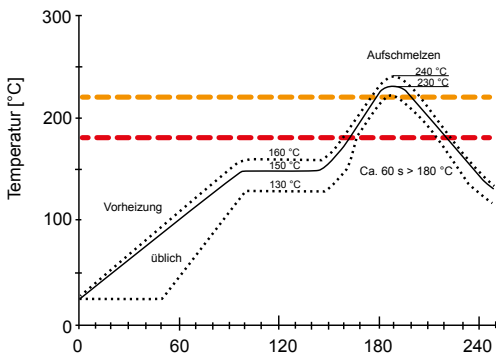


Figure VIII-3: Soldering profile for reflow soldering (temperature measured in the solder joint)

## 6. HARTING SMC/SMT

The continuing trend towards miniaturisation has revolutionised the assembly of electronic components. Since the 1990s, most of the components are mounted directly to the circuit board surface using Surface Mount Technology (SMT). By eliminating the mounting holes in the circuit board, a space savings of up to 70 percent is achieved.

Typical parts such as ICs, resistors, capacitors and coils are now processed in mass production almost exclusively using the SMT (Surface Mount Technology).

### SMC technology\*

With SMC technology, the connector is inserted into plated-through holes in the same way as with standard component assembly. All other components can be mounted on the circuit board surface. Placement of the components is carried out with so-called pick-and-place machines. A distinction is made between machines for small and light or those for bulky components. Unlike

ICs, connectors are considered to be bulky components, because they are more difficult to access due to their comparatively heavy weight and volume. Pick-and-place machines for bulky components must also have higher setting forces to fit the components in the PCB holes filled with solder paste. In general, both machine types are available for a modern SMT production line. Therefore, the user usually has no further investment costs with this technology.

VIII

\* Also known as *Pin in Hole Intrusive Reflow, Pin in Paste or Through Hole Reflow (THR)* technology

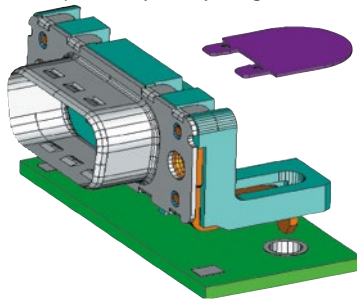


Figure VIII-5: D-sub SMC connector

### Assembly process for conventional assembly

1. Application of solder paste
2. Positioning the components
3. Positioning of bulky components
4. Reflow soldering
5. Press-in operations or partial dip soldering the connector at the panel edge
6. Quality control

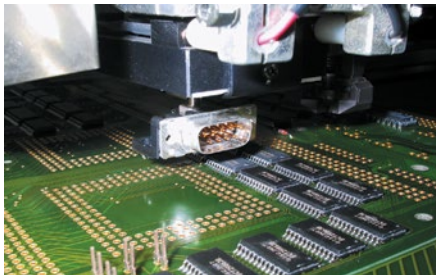


Figure VIII-6: Pick-and-place machine with vacuum pipette and D-Sub

SMC connectors have been specifically developed for use in the SMC process. In addition to the preferred black insert colour used for automatic assembly and machine-friendly packaging, the connectors also offer snap-in clips for attaching to the printed circuit board before soldering.

The open design of the insert made of high temperature resistant plastic ensures homogeneous heat distribution, so that existing soldering profiles can be maintained. The connectors are suitable for even higher temperatures, for example, for lead-free soldering processes.

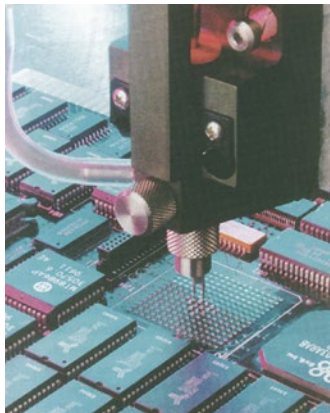
**Advantages of SMC connectors:**

- Partial dip soldering or press-in operations are unnecessary
- High mechanical stability
- Compatible with surface mount technology
- Cost savings through integration into the automated assembly process
- No additional space requirements within the production facility

**Application of solder**

Before the components are assembled, all pads and plated-through interconnection holes are provided with solder paste. Screen printing is the method usually used for this. A squeegee moves across the PCB which is masked with screens and presses the solder paste into all unmasked areas. Good soldering depends essentially on the filled paste volume. This can be calculated using the formula on the next page.

An alternative to the screen printing process is to apply the solder paste using a dispenser. With this method, the paste is applied using a pipette. A high-precision robot moves the dispenser individually and consecutively to all required locations on the circuit board.



*Figure VIII-7: Dispenser in operation*

The dispensing method is particularly suitable for small PCBs or applications where high precision and flexible metering volumes are required.

**Solder paste volume**

A variety of scientific studies deal with calculating the required quantity of solder paste. Here, the different parameters are included in the analysis, for example, the shrinking factor of the paste during soldering or the thickness of the screens used for masking the PCB. Because these calculation methods are complicated to apply, the following rule of thumb has proven to be useful in practice:

$$V_{\text{Paste}} = 2(V_{\text{H}} - V_{\text{P}})$$

with:

$V_{\text{Paste}}$  = Required solder paste volume

$V_{\text{H}}$  = Volume of the plated through-hole

$V_{\text{P}}$  = Volume of the connector termination in the hole

VIII

**Comment:** The multiplier “2” compensates for the shrinking of the solder paste during soldering. The assumption was made that 50 percent of the solder paste consists of actual solder and 50 percent of an auxiliary solder product.

### Requirements for the solder

At the beginning of a new production batch, process parameters such as solder paste and soldering temperature are set by interpreting simple *cross-sections* of the soldered joint. A reliable measure for the optimum choice of parameters is the filling capacity of the solder in the hole. Soldered joints with good quality have a capacity between 75 and 100 percent.

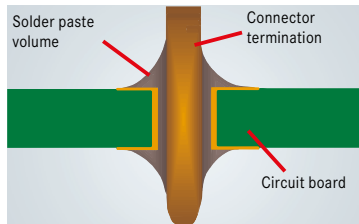
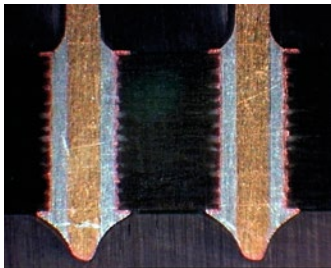


Figure VIII-8: Plated through-hole with connector termination

### Temperatures in the reflow process

With SMT (Surface Mount Technology) and SMC (*Surface Mount Compatible*) connectors, temperatures of up to 260 degrees Celsius must briefly occur on the components during the reflow process. Therefore, the insert must be made of a dimensionally stable plastic that when subject to heat expands in compliance with the PCB material.



## HARTING SMC technology

The length of the connector contacts should be sized so that they protrude by maximum 1.5 millimeters after insertion in the printed circuit board. Because each contact passing through the solder paste in the hole picks up solder on its tip, in the case of a larger contact length, it would can no longer be able to flow back due to capillary action during the soldering process into the plated through-hole, thus impairing the quality of the solder joint.

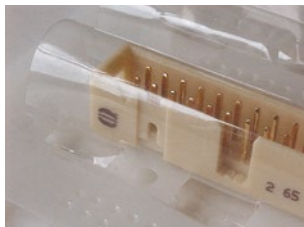
The connector design must allow automatic assembly on pick-and-place machines as well as manual positioning for small and test batches. The machine-ready design of the delivery package is also important. Experience shows that individual chambers made of deep-drawing films, which are rolled up on rolls (reel packaging, tape & reel) and plastic tubes (tubes) are particularly suitable. Plastic trays are used for larger components.

HARTING offers its customers a complete system concept for integrating SMC technology into existing production lines. The company produces a wide range of SMC connectors (2, 3- and 5-row) according to IEC 60 603-2, D-Sub connectors according to CECC 75 301-802 and connectors from the SEK series with connector pitch of 1.27 mm. In addition, HARTING supports the market with packaging and processing concepts that were jointly developed with well-known manufacturers of SMC soldering and pick-and-place facilities.

**Further information on this termination type can be found in the chapter “SMC Technology and PCB connectors” in the catalogue “HARTING Interface Connectors”.**

### Advantages of pin in hole intrusive reflow technology:

- Partial dip soldering or press-in operations are unnecessary
- Full compatibility with surface mount technology
- Full integration into the automated assembly process
- No additional space requirements within the production facility
- Usually no additional investment costs



*Figure VIII-9: SEK connectors in machine-ready packaging*

## 7. Standards

This chapter deals with all relevant soldering standards, guidelines and test methods.

A properly executed solder joint is characterized by a reproducible, constant quality in terms of its mechanical and electrical characteristics. That makes this termination technique particularly interesting for the production of large production series.

To achieve these high quality characteristics, there are various standards and test methods. The most important standards and procedures for inspecting a solder joint are:

- IEC 60068-2-54 – Environmental testing – Solderability testing of electronic components by the wetting balance method
- DIN EN 60068-2-69 (2007-11) – Environmental testing – Solderability testing of electronic components and boards by the wetting balance method
- IPC-A-610 – Acceptance criteria for electronic assemblies
- IPC/JEDEC J-STD-020E (2014) – Moisture/Reflow Sensitivity Classification for Nonhermetic Surface Mount Devices (MSL-Level)
- ECLA/IPC/JEDEC J-STD-075 – Classification of Non-IC Electronic Components for Assembly Processes (PSL Level)

**Solderability according to IEC 60068-2-54 – Environmental testing – Solderability testing of electronic components by the wetting balance method**  
**DIN IEC 60068-2-69 – Environmental factors – Solderability testing of electronic components and circuit boards by the wetting balance method**

Solderability is the ability of a metal to accept the solder and to provide a firm and electrically conductive connection. The two standards mentioned above describe appropriate test methods. They differ mainly in the type of components to be soldered and their technique. A distinction is made between SMC (through-hole components) and SMT technology (surface-mount components). The solderability is checked with a wetting test. Here, flux is applied to the solder connections which are then immersed for 5 seconds in a solder bath. The forces are recorded using a force transducer.

The recorded diagrams and the resulting characteristics gives an indication of the quality of the surface. Moreover, the submerged surface is examined under the microscope. Ideally, at least 95% of the submerged area should be wetted with solder.

Usually this test is performed with three sample states.

1. New contacts/components
2. Contacts/components after 16 hours of exposure at 155°C
3. Contacts/components after 8 hours of exposure to steam

## Visual inspection of the finished solder joints IPC-A-610 - Acceptance criteria for electronic assemblies

The IPC-A-610 is an internationally recognized quality standard that defines visual acceptance criteria for the production of electrical and electronic components. It refers to criteria that are outwardly visible and is applicable to both SMC and SMT soldering. This makes it one of the non-destructive test methods, because *cross-sections* are not needed. Expensive test equipment such as X-ray devices are not required.

The IPC-A-610 divides solder joints into three classes. Depending on the class, there may be differences in the acceptance criteria.

With a solder joint for a radio (Class 1), for example, less solder is needed in the plated through-hole than in a medical diagnostics device (Class 3).

Class 1: General Electronic Products

Class 2: Dedicated Service Electronic Products

Class 3: High Performance Electronic Products

The diagram below shows faulty and fault-free solder joints, contrary to the standard, to better illustrate the micro-section.

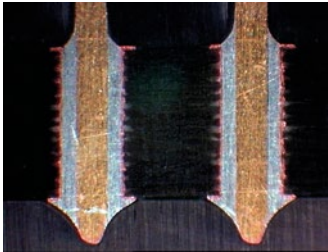


Figure VIII-10: Fault-free soldered joint

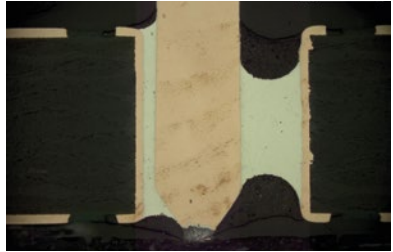


Figure VIII-11: Soldered joint with borderline degree of filling

**Reflow soldering capabilities in accordance with IPC/JEDEC J-STD-020D – Moisture/Reflow. Sensitivity Classification for Non-hermetic. Solid-State Surfaces (MSL Level)**

**ECA/IPC/JEDEC J-STD-075 – Classification of Non-IC Electronic Components for Assembly Processes (PSL-Level)**

Components to be soldered in the reflow process must be suitable for the high temperatures in a reflow oven. This applies especially to the plastic components. The temperature resistance and moisture absorption during storage must be observed.

The ECA/IPC/JEDEC J-STD-075 defines here with the PSL level at which temperatures the insulator's plastic is suitable. The MSL according to IPC/JEDEC J-STD-020D specifies how hydrophilic (attractive for moisture) the insulator's plastic is. This moisture, which is penetrating into the plastic, has an impact on the material behaviour in the reflow oven. If the plastic has absorbed too much water, it causes bubbles during soldering and may burst and change its shape and properties.

Further information on normative requirements for soldered connections can be found in the list of standards.

## 8. HARTING connector product range for soldering/SMC/SMT

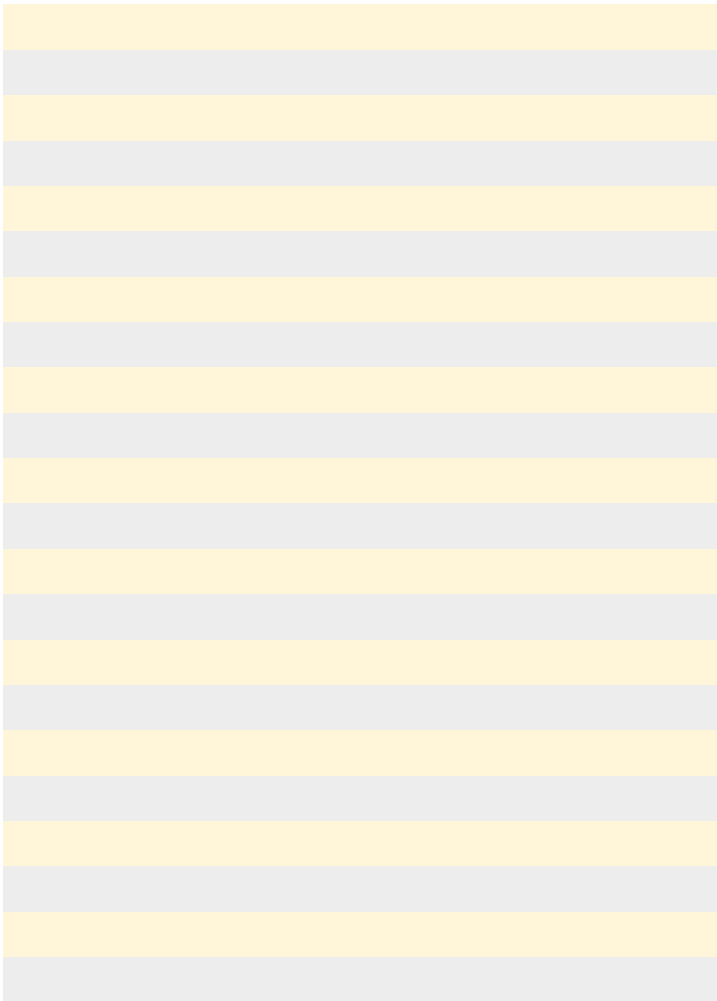
Table VIII-3 provides an overview of the HARTING products that are processed with solder connection technology. For more information on this, please refer to the corresponding catalogue (interface or DIN 41 612).

Table VIII-3: Overview of HARTING connectors for soldering/SMC/SMD

Standard/specification	Size	Pole count	Type/variant
<b>Soldering</b>			
DIN 41 612	B-H	3-160	Female/male
IEC 61 076-4-107 2.0	har-link	10	Female
IEC 60 807	D-Sub	9-50	Female/male
None	D-Sub HD	15-78	Female/male
DIN 41 652 T1	D-Sub Mixed	2-36	Female/male
None	D-Sub Filter	9-37	Female/male
None	D-Sub water-protected	9-50	Female/male
	RJ 45		
IEC 60603-13	SEK	6-64	Male
<b>SMC</b>			
DIN 41 612	C 2C har-bus® 64 F	32-160	Male
DIN 41 612	R	160	Female
DIN 41 612	3C, B, 2B, 3B, D, E, Q, 2Q, 3Q, R, 2R, 3R	2-160	Male
DIN 41 612	3C, 2B, 3B, 2Q, 3Q, 2R, 3R	20-96	Female
None	har-flexicon®	2-25	Base strip / Terminal block
IEC 60 603-13	SEK	6-64	Male
IEC 60 807	D-Sub	9-50	Female/male
IEC 61 076-4-101	har-bus® HM	50-220	Female/male
None	har-flex THR	6-100	Female/male
<b>SMT</b>			
IEC 60 807	D-Sub	9-37	Female/male
None	har-flexicon®	2-12	Base strip / Terminal block
None	har-flex	6-100	Female/male

## Notes

VIII



---

## IX. Wire wrap termination

### Table of Contents

1. Introduction .....	142
2. Wrap types.....	143
3. Tools for the wire wrap technique .....	144

## 1. Introduction

IX

Wire wrap technology does not currently play a major role in the industry. It is used occasionally in telecommunications for the wiring of electrical cabinets. The advantage here is that versatile contact connections can be established, even for large connection grids with many connectors. The wraps must simply be rewound in order to make changes. There is no need to change circuit boards or board layouts. For experienced production personnel, a simple data table should be sufficient to implement any changed requirements during production.

The advantage of the great versatility is offset by the disadvantage of the high cost in manufacturing. Since each connection is made individually by hand, the time and costs required, as well as the error rate are relatively high.

The wire wrap technique refers to the method of wrapping a wire several times around a squared terminal pin. The actual contact is established at the corners of this terminal pin.

When implemented properly, this connection has the following characteristics:

Electrical: minimal contact resistance

Mechanical: firm

Climatic: not sensitive

Thermal: stable

Some examples are described below:

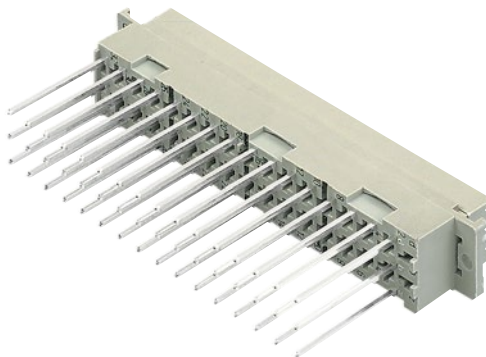


Figure IX-1:  
DIN 41 612 type F with wrapping posts



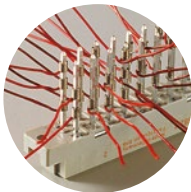
## 2. Wrap types

The requirements for a finished wire-wrap connection, as well as the associated tests and recommendations for materials and dimensions, are specified in DIN EN 60 352-1.

There are two types of wraps: a) Standard wrap  
b) Modified wrap

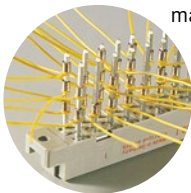
IX

- a) Standard wrap: Only the stripped wire end is wrapped around the pin. The advantage of this wrap type is that the diameter of the wrapped wire's insulation may fluctuate significantly



*Fig. IX-2: Standard wrap*

- b) Modified wrap: An extra wrap is made which includes the wire insulation. The advantage of this wrapping type is that, in the event that the wire unwinds from the pin, no conductive wire material contacts the neighbouring wire wrap.



*Fig. IX-3: Modified wrap*

### 3. Tools for the wire wrap technique

Special wrapping tools which operate pneumatically, electrically or manually, are used to achieve a precise wire wrap. These tools are equipped with wrapping inserts and guide sleeves, which support the wrapped wire and slip over the wrap pin.

The winding insert and guide sleeves to be used depend on the type of wrap, the wire and insulation diameters, and the dimensions of the wrapping (terminal) pins.

The following tables show the maximum number of wraps which (according to IEC 60 352-1) may be applied to the wrapping pin.

Table IX-1: Standard wrap

Valid for standard wraps		Diameter of wrapped wire (mm)						
		0,25	0,32	0,4	0,5	0,65	0,8	1,0
		Max. permitted diameter of wrapped wire, including insulation (mm)						
		0,7	0,9	1,17	1,27	1,32	1,5	1,78
		Min. required number of wraps per wrapping pin (for the stripped wire)						
		7	7	6	5	4	4	4
Dimension of the wrapping pin (mm)	Length of the wrapping pin (mm)	Possible number of wraps per wrapping pin						
0.6 x 0.6	13	6	5	4	4	4	3	2
0.6 x 0.6	17	8	6	6	5	5	4	3
1 x 1	20	10	7	7	6	6	5	4
1 x 1	22	11	8	7	7	6	5	4

Table IX-2: Modified wrap

Valid for modified wraps		Diameter of wrapped wire (mm)						
		0,25	0,32	0,4	0,5	0,65	0,8	1,0
		Max. permitted diameter of wrapped wire, including insulation (mm)						
		0,7	0,9	1,17	1,27	1,32	1,5	1,78
		Min. required number of wraps per wrapping pin (for the stripped wire)						
		7	7	6	5	4	4	4
Dimension of the wrapping pin (mm)	Length of the wrapping pin (mm)	Possible number of wraps per wrapping pin						
0.6 x 0.6	13	4	3	2	2	2	2	1
0.6 x 0.6	17	5	4	3	3	3	2	2
1 x 1	20	6	4	4	3	3	3	2
1 x 1	22	6	5	4	4	4	3	2

---

## X. Insulation displacement termination technique

### Inhalt

1. Introduction .....	146
1.1 Overview of the insulation displacement connection.....	146
1.2 Standards .....	147
1.3 Industrial connectors .....	147
2. Assembly instructions.....	148
2.1 Assembly instructions for Han 3A with HARAX® termination technique.....	148
2.2 Assembly instructions for unshielded HARAX® M8/M12 .....	149
2.3 Assembly instructions for shielded HARAX® M12.....	150
2.4 Assembly instructions for HARAX® Pg 13.5/M20 panel feed through.....	151
3. Interface connector .....	152
3.1 D-Sub standard.....	152
3.2 SEK .....	153
3.3 DIN 41 612 connectors .....	155
3.4 Tools for interface and DIN 41 612 connectors .....	155
3.5 Ethernet interfaces .....	158
3.6 Assembly instructions for Ha-VIS preLink® RJ45 connector .....	173
4. Piercing termination technique .....	174
4.1 Piercing termination overview.....	174
4.2 Assembly instructions for HARTING RJ Industrial® Gigalink Cat. 6 <sub>A</sub> IP20.....	175
4.3 Assembly instructions for HARTING RJ Industrial® 10G IP65 / 67 ....	179

X

## 1. Introduction

### 1.1 Overview of the insulation displacement connection

IDC (insulation displacement connection) is a solder-free electrical connection technique. A non-stripped single wire is pressed into a downwardly tapered terminal, thus establishing a conductive electrical connection. This connection is established as the cutting terminal cuts through the wire insulation. The inner wire core is then shaped so that a gas-tight connection is created that is resistant to corrosion. This wire termination technique has been used in the data and telecommunications industry since 1970. It can be used for both solid round wires or stranded wires.

In an optimal insulation displacement connection, the individual wire cores are deformed (as shown in Figure X-1) so that they support each other.

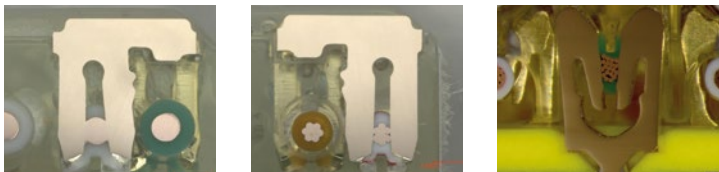
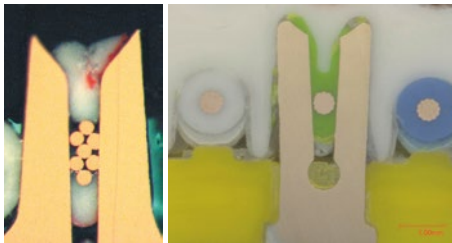


Figure X-1:  
*Optimal insulation displacement connection for rigid and flexible (stranded) wires*

Figure X-2 and X-3 show poor insulation displacement connections. Here, the individual wires are insufficiently deformed; they do not support each other.

Figure X-2 and X-3:  
*Poor insulation displacement connections*



## 1.2 Standards

The following standards apply to insulation displacement connections:

- EN 60 352-3 Solderless electrical connections, part 3: solder-free accessible insulation displacement connections
- EN 60 352-4 Solderless electrical connections, part 4: solderless non-accessible insulation displacement connections

The following chapters describe the assembly instructions for HARTING components that use insulation displacement terminals. More detailed product information can be found in the corresponding catalogues.

**X**

For the part numbers listed below, when an x is used in a part number, it is a placeholder for any valid digit.

## 1.3 Industrial connectors

For HARTING's industrial connectors, insulation displacement technology is used for the following connector types:

- Han® 3 A with HARAX® termination technique
- HARAX® M8/M12 circular connectors
- HARAX® panel feed throughs in PG and metric
- HARTING RJ Industrial® RJ45 connectors and female sockets
- preLink® RJ45/M12 connectors and female sockets
- SEK connector systems
- DIN 41 612 Connectors
- D-Sub connectors

## 2. Assembly instructions

### 2.1 Assembly instructions for Han 3A with HARAX® termination technique

Part number:  
09 20 003 044x  
male/female

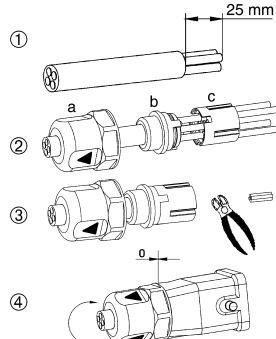


Figure X-4: Han® 3 A with HARAX® termination technique

Table X-1: Technical characteristics

Cross-section	0.75 – 1.5 mm <sup>2</sup>
Cable diameter	6.0 – 9.0 mm
Wire diameter	≤ 2.8 mm
Diameter of single wire	≥ 0.2 mm
Wire insulation material	PVC
Tightening torque for fitting nut	8.0 Nm

### Assembly

	1. Remove cable sheath
	2. Put on the HARAX® elements
	3. Snap in the seal insert and the splice ring. Cut off the wire ends.
	4. Screw in the fitting nut until it reaches the detents.
	a = Fitting nut b = Seal insert c = Splice ring
	The fitting nut, seal and splice ring are included in delivery.
	They can be re-connected ten times.

## 2.2 Assembly instructions for unshielded HARAX® M8/M12

Part numbers:

21 02 151 xx05	HARAX® M8-S straight version, 3-/4-poles
21 03 111 x405	HARAX® M12-S straight version, 4-poles
21 01 1x0 50x1	HARAX® M12 angled version, 3-/4-poles
21 03 212 xx0x	HARAX® M12-L straight version



Figure X-5: HARAX® M8-S



Figure X-6: HARAX® M12-S



Figure X-7: HARAX® M12 angled



Figure X-8: HARAX® M12-L

Table X-2: Technical characteristics

	M8-S/M12-S	M12 angled	M12-L
Cross-section	0.14 – 0.34 mm <sup>2</sup> AWG 26 – 22	0.25 – 0.5 mm <sup>2</sup> AWG 24/7 – 22	0.34 – 0.75 mm <sup>2</sup> AWG 22 – 18
Wire strand diameter	≥ 0.1 mm	≥ 0.1 mm	≥ 0.1 mm
Wire insulation material	PVC/PP/TPE	PVC	PVC
Wire diameter	1.0 – 1.6 mm	1.2 – 1.6 mm	1.6 – 2.0 mm
Cable diameter	M8-S: 3.2 – 5.4 mm M12-S: 4.0 – 5.1 mm	4.0 – 5.1 mm	5.5 – 8 mm

### Assembly

	<ol style="list-style-type: none"> <li>1. Remove cable sheath</li> <li>2. Put on HARAX® elements</li> <li>3. Cut off wire ends</li> <li>4. Screw on</li> </ol> <p>Ⓐ Fitting nut Ⓑ Strain relief Ⓒ Splice ring</p> <p>Screw the fitting nut in until it reaches the end stop on the insert.</p> <p><b>Note!</b> Cut off any used cable ends before further usage. Repeat steps 1 to 4.</p>
--	---

## 2.3 Assembly instructions for shielded HARAX® M12

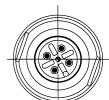
Part number:  
21 03 2x1 xx0x  
HARAX® M12-L shielded



Figure X-9: HARAX® M12-L shielded

Table X-3: Technical characteristics

	M12-L	M12-L Ethernet	M12-L Profibus
Cross-section	0.25 – 0.34 mm <sup>2</sup> AWG 24 – 22	0.25 – 0.34 mm <sup>2</sup> AWG 24 – 22	0.25 – 0.34 mm <sup>2</sup> AWG 24 – 22
Wire strand diameter	≥ 0.1 mm	≥ 0.1 mm	≥ 0.1 mm
Wire insulation material	PVC	PVC	PVC
Wire diameter	1.6 – 2.0 mm	1.2 – 1.6 mm	2.0 – 2.6 mm
Cable diameter	7.0 – 8.8 mm	5.5 – 7.2 mm	7.0 – 8.8 mm
Coding system	A	D	B



4-pole  
A-coding



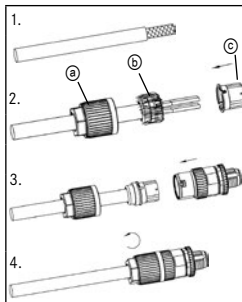
2-pole, Profibus,  
B-coding



4-pole, Ethernet,  
D-coding

Figure X-10: View of mating side, male: HARAX® M12-L, shielded

### Assembly

	1. Remove cable sheath
	2. Push the fitting nut and seal over the cable sheath. Spread the screening braid out. Insert the wires in the splice ring.
	3. Push the connector on the splice ring.
	4. Screw on the fitting nut until it stops.
	Ⓐ Fitting nut Ⓑ Strain relief Ⓒ Splice ring
	<b>Note!</b> Cut off the used cable ends before reuse. Repeat steps 1 through 4.



## 2.4 Assembly instructions for HARAX® Pg 13.5/M20 panel feed through

Part numbers: 21 01 1x0 xxx3 HARAX® Pg 13.5 panel feed through  
 21 01 141 xxx3 HARAX® M20 panel feed through

Figure X-11:  
 HARAX® Pg 13.5/M20  
 panel feed through



X

Table X-4: Technical characteristics

Size	Pg 13.5 – 3 poles	Pg 13.5 / M20 – 4 poles
Specifications	IEC 60 352-4 DIN 61 984	
Cross-section	0.75 – 1.5 mm <sup>2</sup>	
Wire strand diameter	≥ 0.2 mm	
Cable outer diameter	6.0 – 9.0 mm	
Wire insulation material	PVC	
Max. tightening torque	1.2 – 1.6 mm	
They can be re-connected ten times.		

### Assembly

Assembly or removal of the wires may only be carried out by trained professionals when there is no voltage applied.

- Ⓐ Fitting nut
- Ⓑ Strain relief
- Ⓒ Splice ring

HARAX® Pg 13.5 – 3 poles – can be delivered with spade or manual solder connection.

HARAX® Pg 13.5 / M20 – 4 poles – only delivered with manual solder connection.

Screw in the fitting nut until it reaches the detents on the insert.

A tool is required to open this screw joint.

**Note:** Cut off the used cable ends before reuse. Repeat steps 1 through 4.

### 3. Interface connector

#### 3.1 D-Sub standard

Part number:

09 66 x28 x70x

Male connector (header) with shielding clip in protective metal collar

09 66 x18 x50x

Female connectors (header) in protective metal collar

X



Figure X-12: D-S D-Sub standard



Figure X-13: Strain relief clamp

Table X-5: Technical characteristics for D-Sub standard

Number of contacts:		9, 15, 25, 37
Connection pitch:		1.27 mm
Cross-section/wire gauge for connected wires	Stranded wires	AWG 28/7
		AWG 26/7
	Solid wires	AWG 30/1
		AWG 28/1

To connect the cable, use the appropriate tool for these inserts along with the corresponding accessories. Follow the assembly instructions that accompany the tools.

### 3.2 SEK

The SEK (insulation displacement technology) is a connector system with a 2.54 mm connector pitch. It is used to connect ribbon cables to circuit boards. A male connector (soldered to the circuit board) is used for the PCB connection. For the cable side, a female connector (with IDC) is used. The cable can also be directly connected (with IDC) to a soldered-on PCB connector.

*Table X-6: Technical characteristics, valid for all SEK series*

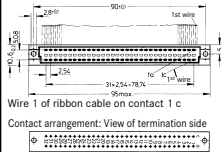

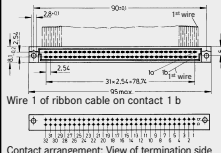

Number of contacts:	6, 10, 14, 16, 20, 26, 30 (on request), 34, 40, 50, 60, 64
Connection pitch:	2.54 mm [0.100"]
Terminations:	IDC ribbon cable, with 1.27 mm pitch (0.050") AWG 26/7 – AWG 28/7
Approvals:	IEC 60 603-13 DIN EN 60 603-13 D 2632 BT 224 NFC 93-428 (HE 10)

X



### 3.3 DIN 41 612 connectors

Table X-8: Overview of DIN 41 612 connectors

Part number	Connection pitch (mm)	Electr. termination	Contact arrangement	Product photo
09 03 x64 x828 Female connector 64 poles, with/ without coding Size C	2,54	IDC AWG 28/7		
09 02 264 x828 Female connector 64 poles Size B	2,54	IDC AWG 28/7		

To connect the cable, use the appropriate tool for these inserts along with the corresponding accessories. Follow the assembly instructions that accompany the tools.

### 3.4 Tools for interface and DIN 41 612 connectors

#### D-Sub

Table X-9: Overview of tools and accessories

Part number	Tool	Accessories	Remarks
Connectors  Male connectors 09 66 x28 x70x Female connectors 09 66 x18 x50x	Hand lever press 09 99 000 0114	Support plate 09 99 000 0135	For processing ribbon cables
		Insert component 09 99 600 0201	For processing 37-pole male connectors
	Manual crimper 09 99 000 0149		
		Separating tool 09 99 000 0116	For ribbon cables
		Cutter 09 99 000 0179 Cutting mat 09 99 000 0180	

## SEK

Table X-10: Overview of tools and accessories

Part number	Tools	Accessories	Remarks
09 18 5xx x8xx Female connector with polarisation in middle	Hand lever press 09 99 000 0114	Support plate 09 99 000 0115	For female connectors
		Support plate 09 99 000 0134	For DIP
		Support plate 09 99 000 0131	For circuit board, 2 rows
		Support plate 09 99 000 0130	For circuit board, 4 rows
09 18 1xx 9421 Standard version	Manual crimper 09 99 000 0149	Support plate 09 99 000 0150	For DIN 41612
09 18 1xx 9421 Kinked version (2 kinked contacts/side)			
09 19 0xx 9643 PCB connector 4 rows		Separating tool 09 99 000 0116	
09 17 0xx 9622 Socket connector for IC socket or for soldering on circuit board		Cutter 09 99 000 0179	
		Cutting mat 09 99 000 0180	

## DIN 41612

Table X-11: Overview of tools and accessories, DIN 41612

Connectors	Tool	Accessories	Remarks
09 03 x64 x828 Female connector 64 poles with/ without coding Size C	Hand lever press 09 99 000 0114	Support plate 09 99 000 0150	
		Separating tool 09 99 000 0116	For ribbon cables
09 02 264 x828 Female connector 64 poles Size B		Cutter 09 99 000 0179	
		Cutting mat 09 99 000 0180	

## Manual crimper SEK, D-Sub and DIN 41 612

HARTING's manual crimper for IDC connectors is described below (compare with Tables X-15 to X-17).

Part number: 09 99 000 0149 manual crimper (tool case)



Figure X-14: Manual crimper in case (left) and with tool operational (right)

Table X-12: Overview of the HARTING IDC connectors that can be processed

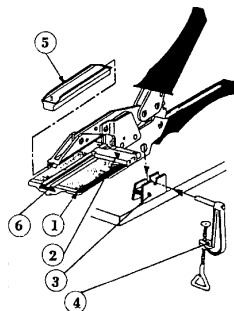
Type	HARTING series	HARTING part number
DIN 41651	SEK 18	09 18 5xx xxxx
PCB	SEK 18	09 18 1xx xxxx
DIP	SEK 17	09 17 xxx xxxx
DIN 41652	D-Sub	09 66 xxx xxxx
DIN 41612	Gds	09 02/03 xxx xxxx

The case contains the following:

1. Manual crimper
2. End stop
3. Table bracket
4. Fixing block
5. Upper section
6. Lower section

### Processing steps:

1. Put the crimper ① in the fixing block ③.
2. Insert the table bracket's bolt ④ through the hole in the crimper. Then tighten the table bracket on the fixing block.



3. Push the inserts (upper ⑤ and lower ⑥ sections) into the manual crimper. No upper section is needed for D-Sub.
4. Position the end stop for the ribbon cable ② to match the number of contacts to be processed.
5. Insert the ribbon cable in the connector's insulation cutting area. Then insert both components in the lower section.
6. Make sure that the ribbon cable is up against the end stop!
7. Push the crimping handles together until the tool lock releases.

X

**Note!**

*When operated improperly, the crimper may open when the safety catch releases.*

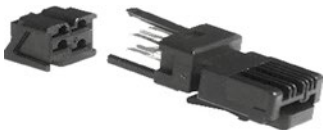
*Table X-13: Connector types, series, number of contacts*

Connector type	HARTING series	Connector part number	Number of contacts	Upper section	Lower section
DIN 41 651	SEK 18	09 18 5xx	6 – 64	SEK 18	SEK 18
DIN 41 652	D-Sub	09 66 xxx	9 – 37		D-Sub
Circuit boards	SEK 18 SEK 18	09 18 xxx	6/10/14/16/ 20/26/34/40	SEK 18-1A	SEK 18-1
			50/60/64	SEK 18-1B	
DIN 41 612 Size B Size C	Gds AB Gds AC	09 02 xxx 09 03 xxx	64 64	Gds Gds	Gds AB Gds AC
IC socket	SEK 17	09 17 xxx	14 – 40	SEK 17	SEK 17

### 3.5 Ethernet interfaces

#### HARTING RJ Industrial® Ethernet connectors Cat. 5

HARTING RJ Industrial® modular connectors are based on the standard RJ 45 mating profile. They have been specially designed for harsh industrial environments. Industrial applications require a connector that can be assembled in the field. Therefore, HARTING has consistently relied on its HARAX® rapid termination technology, which has proven itself in many industrial applications. Users require no special tools to connect the connectors. An RJ45 data module using IDC is at the core of these connectors.



*Figure X-15: RJ45 data module*



No stripping of the wire or special tools are needed to establish a gas-tight connection that is resistant to vibration. The data module has four HARAX® IDC contacts that can establish secure contact with flexible industry-standard Category 5 cable with cross-sections from AWG 22 to AWG 24, as well as solid cable with cross-sections from AWG 22 to AWG 23.

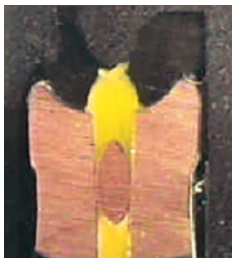


Figure X-16: Contact with solid wire

X

HARTING has developed an entire line of connectors for this data module which meet all industrial application requirements. Solutions are available with IP20 and IP65/67 protection, as well as for various locking lever designs (snap-in, Push Pull, and Han® 3 A).

The RJ45 connectors meet the following technical characteristics:

<b>Transmission properties according to Category 5 ISO/IEC 11 801:2002 and EN 50173-1</b>	
Mating geometry:	RJ45 according to IEC 60 603-7
Wire diameter specifications:	AWG 22 – 24 flexible (stranded) AWG 22 – 23 solid
Wire insulation:	max. 1.6 mm Ø

Table X-14: Overview of HARTING RJ Industrial® Cat.5 connectors

Part number	Description	Remarks	Product photo
09 45 151 1100	HARTING RJ Industrial® IP20 Data, 4 poles	Cable diameter 6.5 mm – 6.9 mm	
09 45 145 1100	HARTING Push Pull, V 4 4 poles (metal and plastic)	Cable diameter 4.9 mm – 8.6 mm	
09 35 221 0421	Han® Push Pull, V 14 4 poles (metal and plastic)	Cable diameters up to 9 mm	
09 45 1x5 110x	Han 3 A® RJ45 4 poles, Cat. 5 IP65 / 67 (metal and plastic)	Cable diameter 6.5 mm – 6.9 mm	
09 45 125 1300 10 12 005 2001	Han 3 A® RJ45 Hybrid 4 poles, Cat. 5 + 4x Power 48V/16 A DC) metal and plastic)	Cable diameter 10 mm – 11 mm Wire diameter for supplying power: 4 x 1.5 mm <sup>2</sup> stranded	
0945 400 1100	Han-Modular® RJ45 insert 4 poles, Cat. 5	Cable diameter: 4 – 8 mm	
0915 300 0412	Han-Max® RJ45 4 poles, Cat. 5 IP65 / 67	Cable diameter: 4 – 8 mm	

## Assembly instructions for HARTING RJ Industrial® Ethernet connectors Cat. 5

The assembly of the data module is identical for all variants.

Table X-15: Contact assignments according to the PROFINet® directive

Signal	Function	Wire colour	Contact number RJ45
TD +	Transmit data +	Yellow	1
TD -	Transmit data -	Orange	2
RD +	Receive data +	White	3
RD -	Receive data -	Blue	6

X

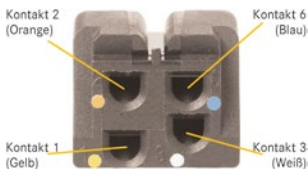
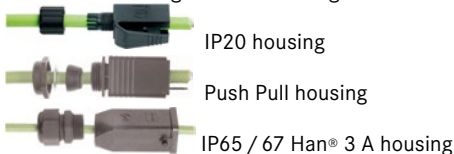


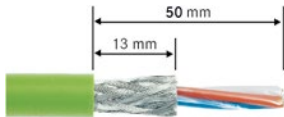
Figure X-17: Rear view of data module

### Assembly

1. Push the cable gland and housing over the cable insulating sheath.



2. Strip 24 mm from the cable sheath and 13 mm from the shielding braid.



3. Prepare the wires for insertion into the splice element according to the colour coding.

X



4. Fully insert the wires into the splice element until flush with the end.



5. Put the splice element on the RJ45 data module and snap it in.



6. Insert the data module and the splice element into the IDC assembly tool provided.



7. Squeeze together the data module and IDC assembly tool to create the IDC connection.



8. Remove the assembled data module from the IDC assembly tool.



9. Put on the upper shielding shell and press it over the cable screen.



10. Add the lower shielding shell; snap it together with the upper metal shield until it engages with an audible click.



X

11. IP20 Data and HARTING Push Pull: Push the housing over the assembled data module until it engages with an audible click.

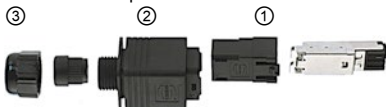


IP20 Data



HARTING PushPull

12. Han® Push Pull: Put the HARTING RJ Industrial® insert ① in the RJ45 holder ②, then push back into the housing ③ (pay attention to the symbols!) – and snap in.



13. IP65 / 67 Han® 3 A RJ45: Place the data module in the adapter and push into the housing. Secure the adapter using the sealing screw.



12. Tighten the cable clamp.

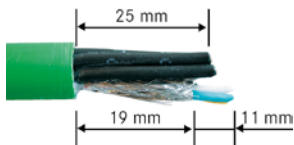
## Assembly instructions for HARTING RJ Industrial® Hybrid

1. Plastic housing: Remove the two collars from the universal sealing ring in order to fit it onto the hybrid cable. Push the cable gland, pressure screw, universal sealing ring and housing over the cable sheath.



X

2. Metal housing: Guide the cable clamp and housing over the hybrid cable.
3. Strip the cable sheath and screening braid to the proper length (for power wires to 25 mm; screening braid to 19 mm; for data wires to 11 mm, total of 30 mm).



4. Prepare the wires for insertion into the splice element according to the colour coding.



5. Fully insert the data wires into the splice element until flush with the end.



6. Put the splice element onto the RJ45 data module and snap it in.



7. Insert the data module and the splice element into the IDC assembly tool provided.



8. Squeeze together the data module and IDC assembly tool to create the IDC connection.



9. Remove the assembled data module from the IDC assembly tool.



10. Put on the upper shielding shell and press it over the cable screen. Add the lower shielding shell; snap it together with the upper shield until it engages with an audible click.



X

11. Prepare the power wires and insert them all way into the hinge element of the insert.

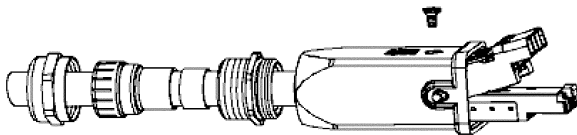


X

12. Press the individual hinge elements together with the integrated IDC contact. We recommend using a small slotted screw driver (max. 3.5 mm) as a lever.



13. Metal housing: Push the housing over the assembled data module and insert. Secure the insert using the housing's locking screw. Tighten this screw using 0.5 Nm torque.



14. Tighten the cable clamp. We recommend using an open-ring spanner wrench with a spanner width (SW) of 21 mm.



## Industrial outlet Cat. 5

Part number:

09 45 815 1100 Han® 3 A metal outlet RJ45



Figure X-18: Han® 3 A metal outlet RJ45

Table X-16: Technical characteristics

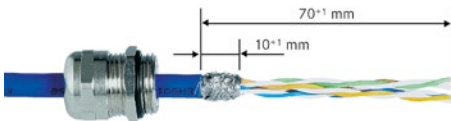
Transmission properties	Link performance Class D according to ISO/IEC 11801:2002 or EN 50 173:2002 Suitable for Fast Ethernet/Ethernet
Termination technique	2 x LSA-PLUS® Rapid termination technique
Wire diameter	AWG 26 – 22 (0.35 – 0.65 mm) Solid wire; stranded wire on request
Wire insulation	0.7 – 1.6 mm Ø (PE/PVC insulation) 0.7 – 1.85 mm Ø (foam insulation)
Diameter of cable sheath	5 – 9 mm

## Assembly instructions for Industrial outlet Cat. 5

1. Fasten the outlet with two screws ( $\varnothing_{\max} = 6.5 \text{ mm}$ ).



2. Open the cover. Insert the cable and strip it. For cables with sheath diameters less than 6 mm, peel back the screening braid over the sheath in order to ensure a secure shield connection.



3. Use a cable clamp to secure the screening braid and then attach the wires. Use the corresponding LSA-PLUS® tool (HARTING part number 09 45 800 0020).



### Note!

*The wires must be twisted and directly routed to the LSA-PLUS® header. Carefully remove the remaining cut wire pieces.*

4. Screw on the cover (use max. 2 Nm tightening torque).

Table X-17: Contact assignments




Contact	EIA/TIA568 A	EIA/TIA568 B	PROFINET
1	gn-wh	or-wh	ye
2	gn	or	or
3	or-wh	gn-wh	wh
4	bl	bl	-
5	bl-wh	bl-wh	-
6	or	gn	bl
7	br-wh	br-wh	-
8	br	br	-

The colour codes on the LSA-PLUS® header correspond to EIA/TIA568 B. Only contacts 1, 2, 3 and 6 are required for two-pair applications.

X

## Industrial outlet Cat. 6

Table X-18: Overview of Industrial outlets Cat. 6

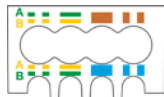
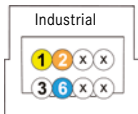
Part number	Description	Technical characteristics	Product photo
X 0945 851 0000 0945 851 0001 0945 545 1563/ 0945 545 1564	DIN rail outlet RJ45, IP20	Transmission properties: Category 6/Class E <sub>A</sub> up to 500 MHz according to ISO/IEC 11 801:2002, EN 50 173-1 Termination technique: IDC Wire diameter: AWG 24 - 22 / 27 - 26	
0945 845 1500 0945 845 1501	HARTING Push Pull outlet RJ45, black/ white	Transmission properties: Category 6 according to ISO/IEC 11801:2002 or EN 50173:2002 Termination technique 2 x LSA-PLUS® Rapid termination technique Wire diameter: AWG 24 - 22 Solid and stranded Diameter of wire insulation: 0.7 - 1.6 mm Diameter of cable sheath: 6 - 9 mm	
0945 815 1560 2082 102 0101	Han® 3 A Metal outlet RJ45	Transmission properties: Category 6A according to ISO/ IEC 11801:2002 For Class E transmission paths Termination technique: IDC, category 6 Wire diameter: AWG 24 - 22 Solid and stranded Diameter of cable sheath: 6 - 9 mm	

## Assembly instructions for HARTING RJ Industrial® RJ45

1. Remove the cable sheath and peel back the screening braid over the cable sheath. Remove the wire shielding in pairs. Untwist the pair of data wires. Then position them properly according to the wiring label/sticker.

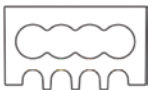
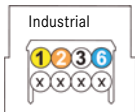


- 2a. Wiring for the 8-pole modules 09 45 545 1561 / ...1562



Colour-coded wire manager,  
according to TIA/EI 568  
version A/B and 4-pole  
industry standard

- 2b. Wiring for the 4-pole modules 09 45 545 1120



Colour-coded wire manager,  
according to 4-pole  
industry standard

3. Insert the wires in the wire manager according to the wiring label and your desired wire assignments.



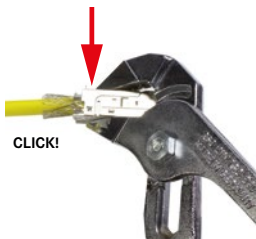
4. Cut the individual wires flush with the end of the wire manager.



5. Press the wire manager and cable into the HARTING RJ Industrial® RJ45 module.



6. Close the HARTING RJ Industrial RJ45 module. An assembly tool may also be used.

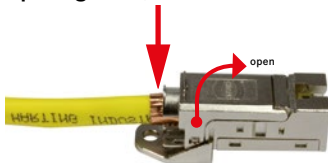


X

7. Secure the cable using a cable tie. Cut off any excess screening braid.



### Opening the RJ45 module



- Use release tool 20 82 000 9916 to open the module.
- Use the release tool as shown. Push in until the module opens.

### Technical characteristics

Transmission properties according to Cat. 6

ISO/IEC 11801:2002 and EN 50173-1

Degree of protection:

IP20

Mating geometry:

RJ45 female, acc. to IEC 60 603-7

Mating cycles:

> 750

Termination technique:

IDC rapid termination

Operating temperature:

-40 °C – +70 °C

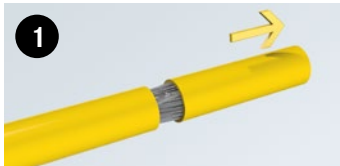
Wire cross-sections solid/stranded:

09 45 545 1561 AWG 27 – 24  
09 45 545 1120 / 1562 AWG 24 – 22

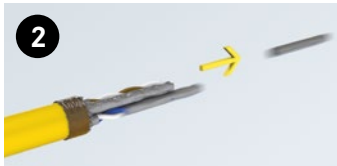
Max. wire diameter:

09 45 545 1561: 1.2 mm  
09 45 545 1120 / ...1562: 1.7 mm  
5 – 9 mm

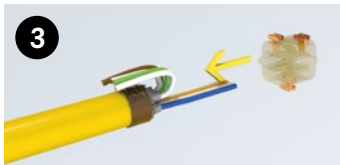
### 3.6 Assembly instructions for Ha-VIS preLink® RJ45 connector



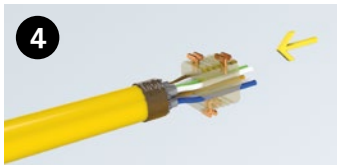
1. *Unsheath the cable.*



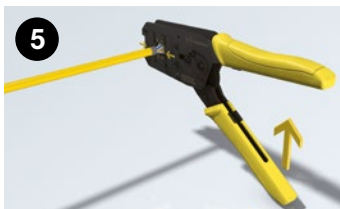
2. *Prepare the shielding.*



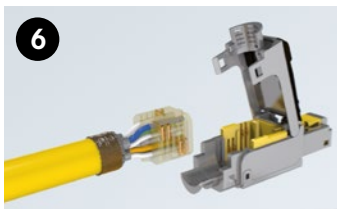
3. *Arrange the wires according to the colour codes.*



4. *Insert the wires in the terminating block according to the colour codes.*



5. *Use the assembly tool 2082 000 9901 to press in the cutting terminals and to cut off the wires.*



6. *Insert the terminating block into the connector.*



7. *Close the connector and secure in place using a cable tie.*



X

## 4. Piercing termination technique

### 4.1 Piercing termination overview

#### Standards

The following standard applies to the piercing termination technique:

- EN/IEC 60352-6

#### **HARTING RJ Industrial® Gigalink connectors, Cat. 6 A**

Like the HARTING RJ Industrial® Cat. 5, the HARTING RJ Industrial® Gigalink connectors are based on the standard RJ45 mating profile. However, the piercing technique is used for the four-pair Gigalink variants.

X

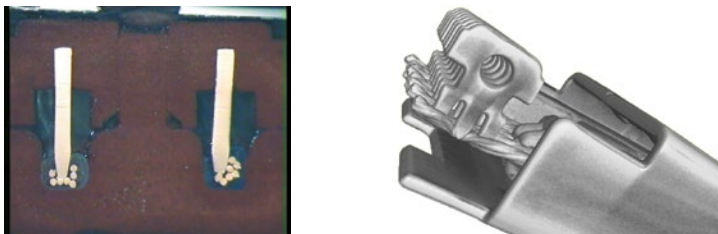


Figure X-19: Micro-section of piercing termination technique

HARTING has developed an entire line of connectors for the Cat. 6<sub>A</sub> Gigalink data module which meet all industrial application requirements. Solutions are available with IP20 and IP65/67 protection, as well as for the standard, Push Pull, and locking lever designs.




The HARTING RJ Industrial® Gigalink Cat. 6<sub>A</sub> connectors satisfy the stricter requirements of Category 6 according to TIA/EIA 568 B.2-1:2002-06, EN 50173-1:2002 and ISO/IEC 11 801:2002-09.

The RJ45 connectors meet the following technical characteristics:

Mating geometry	RJ45 according to IEC 60 603-7
Diameter of individual wires	0.8 – 1.05 mm
Wire cross-section	AWG 28 – 24, stranded



Table X-19: Overview of HARTING RJ Industrial® Gigalink connectors, Cat. 6<sub>A</sub>

Part number	Description	Remarks	Product photo
09 45 151 1520	HARTING RJ Industrial® Gigalink Cat. 6 <sub>A</sub> IP20, 8 poles	Cable manager, white/blue Cable diameter 5.8 mm – 6.9 mm	
09 45 145 1520	HARTING Push Pull connector set RJ45, 8 poles	Cable manager, white/blue Cable diameter 5.8 mm – 7.2 mm	
09 45 1x5 1520	Han® 3 A connector set RJ45, 8 poles	Cable diameter 5 mm – 9 mm	

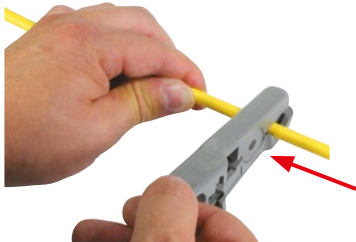
X

## 4.2 Assembly instructions for HARTING RJ Industrial® Gigalink Cat. 6<sub>A</sub> IP20

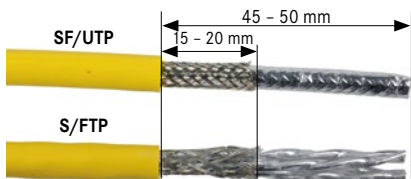
1. Push the cable clamp and housing over the cable.



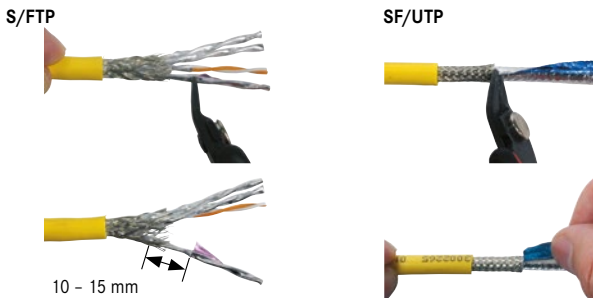
2. Strip the cable sheath and screening braid.



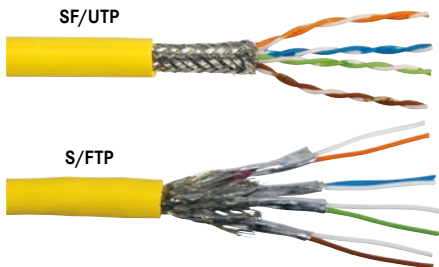
Tool  
09 45 800 0002



X 3. Cut into and remove the screen foil.



4. Unwind the cable pairs and bend to the correct position.



- Bend the wires and insert up to the shielding into the cable manager. The shielding foil for the wire pairs of S/FTP cables must reach to the die-cast zinc wire manager.

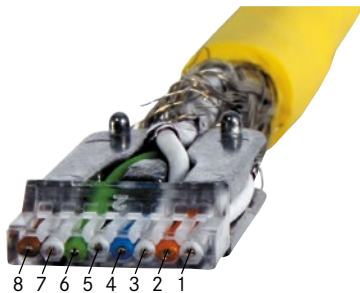
SF/UTP



S/FTP



- Cut off the protruding ends of the wires so that no short circuits are possible. No more than 0.3 mm of excess wire is permitted.



EIA / TIA 568B

- Insert the cable and cable manager until it comes to a stop in the RJ45 data module.

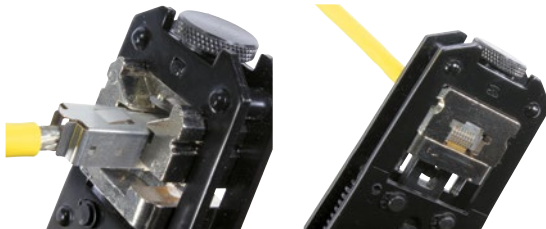


8. Put on the upper shielding shell and press it over the cable screen.

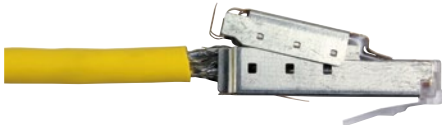


9. Press the contacts into the RJ45 data module with the HARTING RJ Industrial® assembly tool (part no. 09 45 800 0520). Ensure that the data module is pushed into the tool until it stops.

X



10. Add the lower shielding shell; snap it together with the upper shielding shell until it engages with an audible click.



11. Push the housing over the assembled data module until it snaps in with an audible click.



12. Tighten the cable clamp.



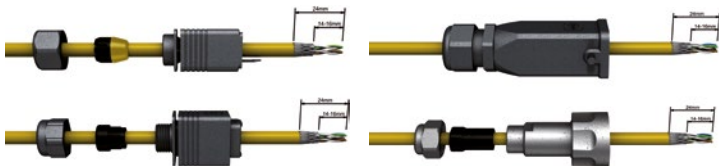
## Contact assignments

Contact	EIA / TIA 568 A	EIA / TIA 568 B
1	green / white	orange / white
2	green	orange
3	orange / white	green / white
4	blue	blue
5	blue / white	blue / white
6	orange	green
7	brown / white	brown / white
8	brown	brown

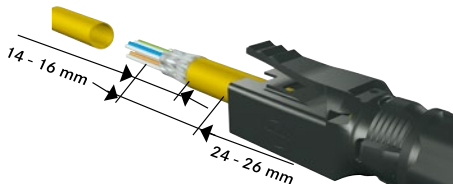
X

### 4.3 Assembly instructions for HARTING RJ Industrial® 10G IP65 / 67

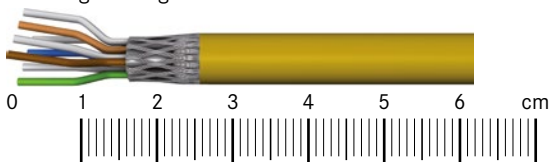
1. Push the cable clamp and housing over the cable sheath.



2. Strip the cable sheath over a length of 24 – 26 mm and the screening braid over 14 – 16 mm.

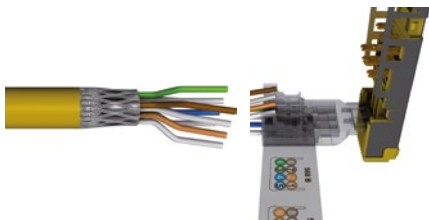


3. To guarantee simple assembly, check the stripping lengths from the following drawing at a 1:1 scale.

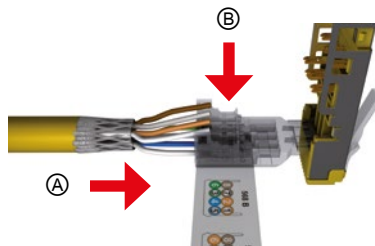


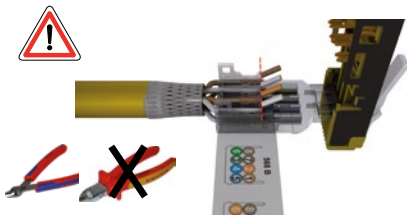
X

4. Sort the cables into their correct positions according to the selected colour coding before placing them into the cable manager.

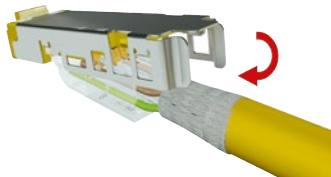


5. Place the lower four cables according to the selected colour coding into the cable manager. Then place the upper four cables into the cable manager and press them in gently with your thumb. Use a small side cutter to cut the upper four wires to the correct length.





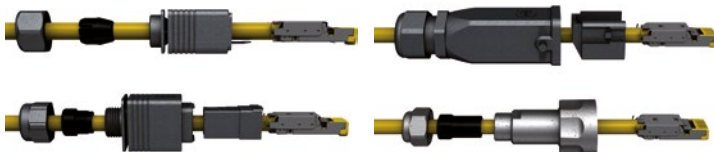
6. Close the cable manager. It closes with an audible click.



7. Snap the shielding shell together. It closes with an audible click.



8. Push the connector housing over the assembled data module (place the data module in the RJ 45 holder, if required) until it snaps in with an audible click (or secure it with the sealing screw). When pulling back, observe the symbols on the connector. Then tighten the cable clamp.



X

## Contact assignments

Contact number	Function/ Signal	Wire colour		
		TIA/EIA 568 A	TIA/EIA 568 B	Industrial 1)
1	T3	green / white	orange / white	yellow
2	R3	green	orange	orange
3	T2	orange / white	green / white	white
4	R1	blue	blue	-
5	T1	blue / white	blue / white	-
6	R2	orange	green	blue
7	T4	brown / white	brown / white	-
8	R4	brown	brown	-

X



---

## XI. Press-in technology

### Table of Contents

1. Introduction .....	184
2. Definition of press-in technology .....	184
3. Recommended hole layout on the circuit board.....	185
4. Press-in tools .....	190
5. Information on hand-lever and pneumatic presses .....	192
6. Overview of HARTING connectors with press-in technology .....	194
7. Requirements for press-in technology.....	195
8. HARTING presses.....	195
9. Conclusion .....	197

## 1. Introduction

A press-in (“press-fit”) connection is a solderless electrical connection made by inserting a press-in termination pin into a plated-through hole in a circuit board. A defining characteristic is that the press-in pin has a greater cross-section (diagonal) than the hole in the circuit board that is being contacted. So there is pressure exerted on the board as the pin is inserted into the hole. The hole in the circuit board and the elastic press-in zone both absorb this deformation force.

XI

From the start, HARTING has relied on an elastic press-in zone. We started with the “Sigma” press-in zone and now use the “needle eye”. It’s important for HARTING that the connections are simple and reliable to process. Our top priority is that the press-in force is absorbed by the insert and not by delicately constructed processing tools.

HARTING press-in connectors have been designed to be easily pressed in using a flat stamping die. This transmits the press-in force directly to the housing.

The press-in technology has become a well-recognized, widely used method for establishing solderless connections. This termination technique is easy to implement and is highly reliable.

## 2. Definition of press-in technology

According to IEC 60352-5 (2012-02):

The press-in connection is made by pressing elastic (deformable) or solid (rigid) pins into the plated-through holes of printed circuit boards. This creates a gas-tight, highly conductive contact between the contact’s press-in zone and the board’s hole or the printed conductive paths.

### 3. Recommended hole layout on the circuit board

While soldered connections require only minimal changes of the circuit board characteristics according to the termination side of the contact, the press-in technology requires a careful adaptation of the terminating pin to the circuit board. The dimension of the contacted circuit board hole is particularly important here.

If the hole is too small, the hole's copper collar can be damaged by the press-in force. If, however, the hole is too large, the required holding force may not be achieved. This would result in unreliable contact or interruptions in the contact.

With elastic press-in technology, both the elastic and the permanent deformations are absorbed in the contact's press-in zone. The mechanical energy is stored in the elastic deformation of the termination pin, and the contact pressure is maintained. Any deviations in the circuit board's hole diameter are then compensated by this elastic deformation.

XI

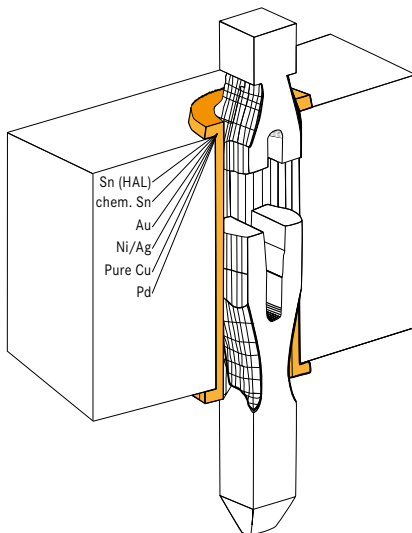


Figure XI-1: Schematic view: press-in zone in plated through-hole

HARTING recommends the following hole layouts for different surfaces.

Table XI-1: Examples of hole dimensioning, with contact layer

Circuit board hole diameter		1 mm	0.6 mm
Hole Ø		1.15±0.025 mm	0.7±0.02 mm
Copper (Cu):		min. 25 µm	
Sn circuit board	Sn	max. 15 µm	max. 15 µm
	End hole Ø	0.94 – 1.09 mm	0.60 – 0.65 mm
Chem. Sn Circuit board	Sn	min. 0.8 µm	min. 0.8 µm
	End hole Ø	1.00 – 1.10 mm	0.60 – 0.65 mm
Au / Ni Circuit board	Ni	3 – 7 µm	3 – 7 µm
	Au	0.05 – 0.12 µm	0.05 – 0.12 µm
	End hole Ø	1.00 – 1.10 mm	0.60 – 0.65 mm
Ag circuit board	Ag	0.1 – 0.3 µm	0.1 – 0.3 µm
	End hole Ø	1.00 – 1.10 mm	0.60 – 0.65 mm
OSP Cu Circuit board	End hole Ø	1.00 – 1.10 mm	0.60 – 0.65 mm
Board thickness: ≥ 1.6 mm		≥ 1.6 mm	≥ 1.4 mm

Table XI-2: Connectors – DIN 41 612 – har-bus® 64, IEC 61 076-4-100 – Mini Coax, DIN SEK, har-bus® HM, D-Sub

A	Board thickness	min. 1.4 mm
B	Diameter of end hole	0.55 +/-0.05 mm
C	Hole	0.64 +/-0.01 mm
D	Copper	min. 25 µm
E	Surface	- min. 0.8 µm chem. Sn - 0.05 – 0.12 µm Au over 3 – 7 µm Ni
F	Rest ring	min. 0.15 mm

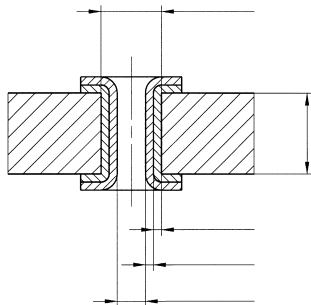


Figure XI-2: Schematic view of the circuit board's hole layout, for a 0.6 mm hole

## 4. Press-in process

The press-in process for connectors involves adapting the terminating pin to the circuit board's contact. Rather than simply pressing the contact in by hand, a hand-lever press or automatic press is used for this process. This ensures the required precision and repeatability. The press-in force is absorbed by the insert. When processing circuit boards with different physical characteristics, it is very important that the mechanical characteristics of the press-in zone have been optimally configured for the circuit board holes.

Three phases describe the connector's press-in process. This process involves mechanical and metallurgical influences.

XI

### Phase 1: Centring and placement of the terminating pin

It is important that the connector is properly centred in order to avoid damaging the circuit board or terminating pins. Centring inaccuracies are negligible when flat stamping dies are being used.

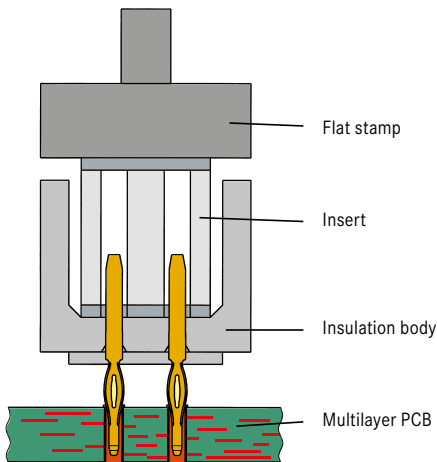


Figure XI-3: Phase 1

### Phase 2: Pressing in the pins

During the pressing in, the shear stress is continuously converted to compressive stress. The resulting rubbing motion cleans the contacting edges from any insulating coating. This ensures a gas-tight connection.

XI

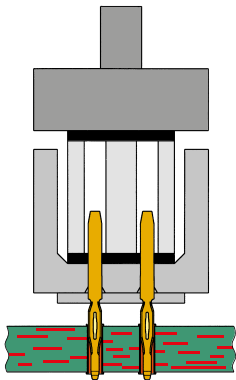


Figure XI-4: Phase 2

### Phase 3: Reaching the end position

The press-in process must be immediately stopped when it reaches the end position. Therefore, excess pressure cannot build up.

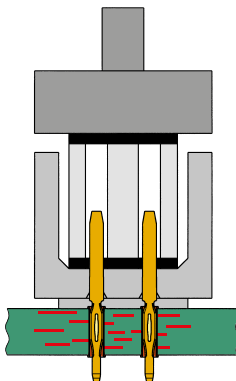
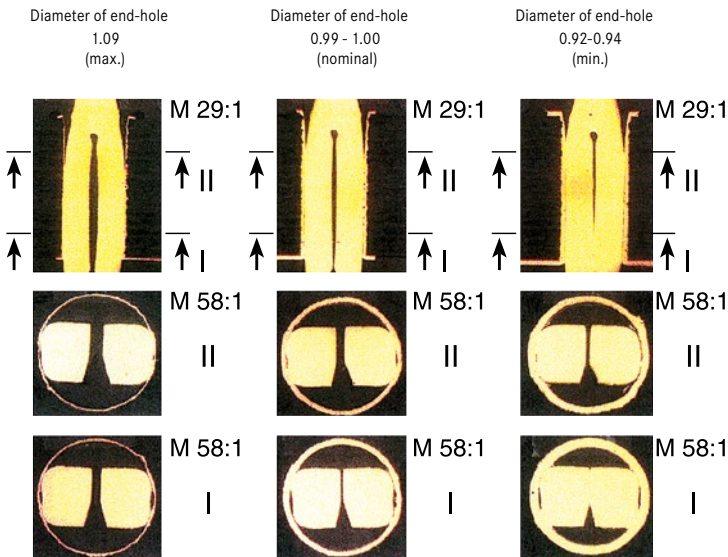


Figure XI-5: Phase 3

The press-in process is now completed.

### Micro-section of HARTING's har-press® press-in zone

The har-press® zone is based on the established needle eye technology. The special shape enables it to compensate when certain tolerance levels are exceeded for the surfaces (e.g. when there is superfluous tin plating). This ensures that a gas-tight electrical connection is created that is resistant to corrosion.



XI

Figure XI-6: Micro-section of a 2.4mm thick circuit board, with varying hole diameters

## 4. Press-in tools

### General

XI

Hand-lever presses and semi-automatic presses are available for pressing in the connectors. The tool must ensure that the press-in force is transmitted via the insulating housing to the contacts. When working with the hand-lever press, a depth end-stop point (bottom dead centre) is defined so that the proper press-in depth is always ensured. Always make sure that the functional surfaces of the contact are not damaged. It is also important to ensure that there are no flaws or damage on the surface of the circuit board. Suitable equipment must be used to ensure that the circuit board is stabilised during the press-in process. This prevents it from being damaged by bending. The stabilisation mechanism must grip the board very close to the hole that the contact will be pressed in. An appropriate holder for the entire circuit board is the best way to ensure that the board does not bend during the press-in process.

There are modular tool systems on the market today which ensure that different connector versions and assembly layouts are processed properly.



## Press-in tools from HARTING

HARTING's modular tool system can be used to make press-in connections with many different connectors. The tools provide a key advantage for a cost-effective workflow. The required basic module of the tool system are:

- Presses
- Press-in stamping dies
- Holding block
- Support plate

XI

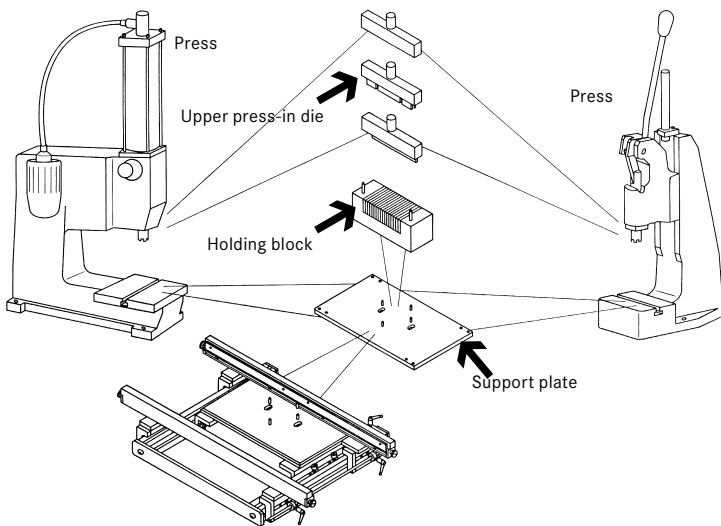


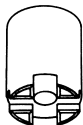
Figure XI-6: Construction of HARTING's modular tool system

## 5. Information on hand-lever and pneumatic presses

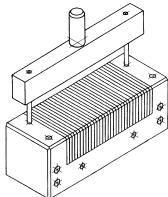
The working height of the press and the support plate must be adjusted when setting up the work place. The instructions accompanying these modules contains further information about these adjustments. No further adjustments are required. The modules can be combined efficiently and reliably in various configurations to match the requirements of your applications.

XI

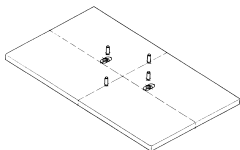
### Height adjustment



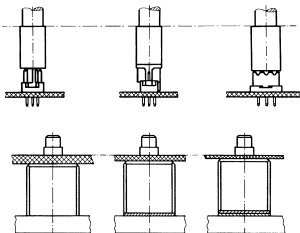
Ram with cross groove



Positioning the holding block for the press-in die



Support plate with pin pairs offset by 90°

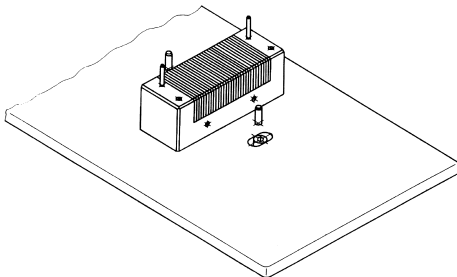


- Different connector heights: Type-specific press-in dies or spacer caps can be used to compensate for height differences
- Varying circuit board thickness: using spacer discs between the holding block and the support plate to compensate for varying thickness

Figure XI-7: Information for using the press-in tools

## Holding block

The all-purpose holding block has a wide range of use. The holding block can be used with all connector sizes that use straight press-in connections in 2.54 mm pitch



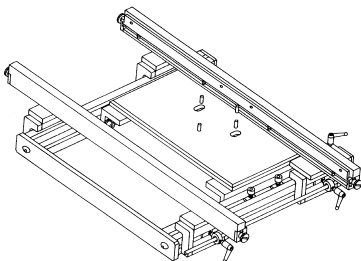
*Figure XI-8:  
Holding block configured to  
hold connectors*

## Guide frame

The guide frame (screwed on the support plate) secures the position of the circuit board for the press-in die. A significantly higher processing speed is thus possible.

Both guide rails can be adjusted to match different board formats.

A spring-loaded support rail lifts the circuit board from the holding block after the press-in step. This prevents the circuit board or conductive paths from being damaged when the guide frame is shifted.



*Figure XI-9:  
Guide frame that positions  
the circuit board for the  
press-in die*

Additional information about HARTING tools can be found in the corresponding catalogues (DIN 41612, interface, metric and device connectivity).

## 6. Overview of HARTING connectors with press-in technology

Table XI-3 lists the HARTING connectors with press-in technology. Specifications have been taken from up-to-date catalogue data.

XI

Table XI-3: Overview of HARTING connectors with press-in technology

Specifications Series	Size	Pole count	Female/male	Standard
DIN 41612	B, 2B	32 + 64	Female	IEC 60 603-2
DIN 41612	C, 2C, 3C	30 – 96	Female	IEC 60 603-2
DIN 41612	M	78 + 2 60 + 4 42 + 6 24 + 8	Female	IEC 60 603-2
DIN 41612	M-flat	78 + 2 60 + 4 42 + 6 24 + 8	Female	IEC 60 603-2
DIN 41612	M inverse	6+10 24+8 42+6 60+4 78+2		IEC 60 603-2
DIN 41612	Q, 2Q	32 – 64	Male	IEC 60 603-2
DIN 41612	R, 2R	32 – 96	Male	IEC 60 603-2
DIN 41612	RM	96	Male	IEC 60 603-2
DIN 41612	E	48	Female	IEC 60 603-2
DIN 41612	F	32 – 48	Female	IEC 60 603-2
DIN 41612	H	15	Female	IEC 60 603-2
IEC 61 076-4-113	-	160	Female	
har-bus <sup>®</sup> HM	A, B, AB, C	55 – 175	Female/male	IEC 61 079-4-101
har-bus <sup>®</sup> HM	D, E, DE	176 – 250	Male	IEC 61 079-4-101
har-bus <sup>®</sup> HM	Monoblock	220 – 308	Female/male	IEC 61 079-4-101
Mini Coax	1 – 1.5 SU	2 – 14	Male/female	
DIN 41 652 CECC 75 301-802 IEC 60 807	Straight	9 – 25 9 – 50	Male Female (V-shaped)	
SEK	-	6 – 64	Male connectors	IEC 60 603-13
PICMG	Advanced TCA mTCA	170	Card Edge	

## 7. Requirements for press-in technology

The quality of a press-in connections depends on three components:

- The circuit board
- The component being connected
- The processing tool

DIN EN 60 352-5 is referenced as the standard for “Requirements and quality testing for press-in connections”.

XI

## 8. HARTING presses

In addition to our tools for processing press-in connectors, HARTING also offers presses. There are three types of presses:

- The hand-lever press
- The pneumatic press
- The CPM press-in machine

Additional information about these presses can be found in the corresponding catalogues (DIN 41612, interface, metric and device connectivity). The associated operating instructions contain more information about adjusting and assembling the presses.

### CPM press-in machine

The latest generation

- Completely programmable
- Suitable for large bulk quantities



### Pneumatic press

- Easy to operate
- Max. press-in force is adjustable
- Suitable for mid-sized batches



### Hand-lever press

- Easy to install
- No electrical or pneumatic connection is required
- Suitable for producing prototypes and small batches



Figure XI-10: Harting's press-in tools and machines

## 9. Conclusion

The following points are critical for achieving a reliable, stable press-in connection:

- The press-in contact, circuit board and press-in tools must all be harmonised to work together.
- The formation of any significant meniscus or residual tin must be avoided (tin chips on the circuit board can lead to device short circuits).
- Be sure not to tear or detach any conductive paths or copper collars during the press-in process. These could prevent the contact from properly contacting the conductive path.

XI

When these points are followed, the benefits of press-in technology listed below are convincing:

- Temperature shocks caused by soldering and the associated risk of board failure are avoided.
- There is no need to subsequently clean the assembled circuit board.
- Additional wrap connections are possible using connectors with long terminating pins.
- An affordable and unrestricted processing method for selective gold plating of pins for backplane bus systems – soldering by hand is no longer necessary!

## Notes

XI



## XII. Fibre optic termination

### Table of Contents

1. Introduction .....	200
2. Planning of optical transmission systems .....	201
2.1 Influencing factors .....	201
2.2 Calculation examples .....	203
3. Assembly of fibre optic connectors.....	205
3.1 F-SMA connector for 1 mm POF with 2.2 mm cable sheath .....	205
3.2 F-SMA connectors for 1 mm POF with 3.6 mm cable sheath.....	207
3.3 F-SMA connectors for 1 mm POF with 6 mm cable sheath.....	209
3.4 Quick-assembly connectors for 1 mm POF with 2.2 mm cable sheath.....	211
3.5 FH-ST connectors for 1 mm POF with 2.2 mm cable sheath.....	212
3.6 FO cable end sleeve for 1 mm POF with 2.2 mm cable sheath .....	214
3.7 F-TNC connectors (female) .....	216
3.8 F-TNC connector (male) .....	218
3.9 F-ST connectors for glas fibre .....	220
3.10 SC contacts for glass fibre.....	222
3.11 LC contact for GI fibre and single mode fibres.....	224
4. FO contacts .....	226
4.1 FO contacts for Han D® and Han DD® contact inserts .....	226
4.2 FO contacts for Han E® inserts.....	228
4.3 FO contacts for 1 mm POF in Han-Modular® .....	230
4.4 FO contacts for GI fibre in Han-Modular® .....	232
4.5 Han-Brid® FO contacts .....	234
5. HARTING four-indent crimp tool operating instructions for 1 mm POF contacts .....	235
6. Tool kit .....	238
6.1 POF assembly kit with optical measuring devices.....	238
6.2 FO measuring device kit .....	240
6.3 GI-fibre assembly kit.....	241
7. Overview of assembly .....	244

## 1. Introduction

In addition to applications in remote connections for messages in the telecommunications sector, the importance of fibre optic technology is also increasing for applications in the industrial sector. In telecommunications, the aspects of

- high transmission capacity
  - low cable attenuation
  - no cross-talk
- are essential for the application.

In the industrial sector, additional specific properties such as

- immunity to electro-magnetic influences
- galvanic isolation of transmitter and receiver
- small cable dimensions

have priority.

Messages are transmitted via fibre optics using light pulses. After coupling into one end of the fibre, the pulses are forwarded as a result of total reflection to the other end with low loss.

This is made possible due to the total reflection at the boundary layer core/sheath due to the different values of the optical refractive index  $n$  of the core and sheath material ( $n_{\text{sheath}} < n_{\text{core}}$ ).

Three types of fibre optics can be distinguished:

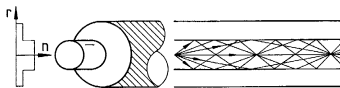
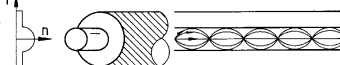

		Typical Dimensions Core/Cladding $\phi$	Attenuation
Step index fibre HCS / POF		200/230 $\mu\text{m}$	5...8 dB/km
		980/1000 $\mu\text{m}$	0.2 dB/m
Graded index fibre GI-fibre		50/125 $\mu\text{m}$	2.6 dB/km
		62,5/125 $\mu\text{m}$	3.2 dB/km
Single-mode fibre		9/125 $\mu\text{m}$	< 0.3 dB/km

Figure XII-1: Path of the optical refractive index

The single mode fibre is used primarily because of its low attenuation and large bandwidth for remote data transmission in the telecommunications sector. However, the graded index fibres and the step index fibres with their

large core diameters are the preferred transmission media in the industrial sector, as they are inexpensive and easy to use. The transmission distances ranging from several tens of meters to several kilometres.

Graded index fibres are usually joined with the connector. With POF (Polymer Optical Fibre) or HCS (Hard Clad Silica)<sup>1)</sup> fibres, crimping technology facilitates the assembly of connectors. With the HARTING quick assembly technique, POF cables can be mounted without any special tools.

HARTING FO systems are designed for graded index fibres (GI) with 50 and 62.5 µm core diameter, single mode fibres with 9 µm and step index fibres with 200 µm (HCS®) and 1 mm (POF). The optical wavelengths used are 660 nm (POF), HCS®, 850 nm (GI, HCS®) and 1300 nm (GI/Single Mode = SM).

#### Footnote:

<sup>1)</sup> A registered trademark of SpecTran Corporation.

## 2. Planning of optical transmission systems

### 2.1 Influencing factors

For a reliable operation of a fibre optic transmission system, it is necessary that the transmitted optical signals reach the receiver with sufficient amplitude. The received power should be at least twice as large (+3 dB) as the limiting sensitivity of the receiver, so that sporadic errors in data transmission do not occur due to system-inherent noise. When planning the system, therefore, a power balance chart should be used to assess if these requirements are met. The influence variables listed below are of importance here.

#### Optical transmitter output power

The optical power generated by the LED is essentially dependent on the supplied current. The portion coupled into the fibre will also be greatly influenced by the core dimensions and the type of fibre used.

Typical power ranges available in the fibre core are:

- for optical fibres ( $\lambda = 850 \text{ nm}$ ):

50 / 125 µm GI-fibre: 80 µW

200 / 230 µm SI-fibre: 250 µW

9 / 125 µm SM-fibre: 20 µW

- for polymer fibre ( $\lambda = 660 \text{ nm}$ ):

980 / 1000 µm: 600 µW

### Specific attenuation of the fibre

The specific attenuation depends on the operation wavelength and is expressed in dB/km.

#### Typical values

1. for optical fibres ( $\lambda = 850$  nm)
  - 50/125  $\mu\text{m}$  GI-fibre: --- 3 dB/km
  - 200/230  $\mu\text{m}$  HCS: --- 5 dB/km
- for optical fibres ( $\lambda = 1300$  nm)
  - 9/125  $\mu\text{m}$  SM-fibre --- 0.5 dB/km
2. for polymer fibres ( $\lambda = 660$  nm)
  - 980/1000  $\mu\text{m}$  (PMMA): --- 0.2 dB/m

This portion typically provides the greatest contribution to total attenuation of the optical path.

### Additional cable joints in the optical cable

Additional cable joints in the optical signal path (splices or connectors) further weaken the transmitted optical signal.

#### Typical values

- for splices:  $\leq 0.3$  dB
- for each connector pair: 0.8 dB to 0.5 dB (GI fibre)

The exact values depend on the type of fibre and the connectors used.

### Sensitivity of the optical receiver

Conventional DC-coupled optical receivers with Si diodes as receiving elements have the following typical limiting sensitivities:

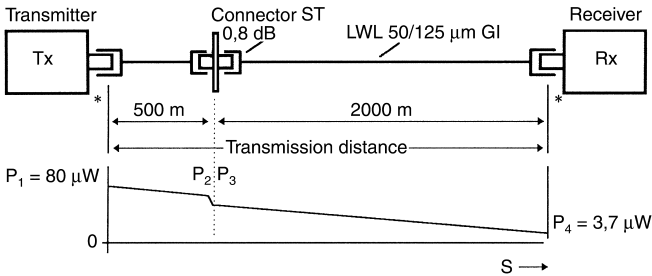
- $\leq 3$   $\mu\text{W}$  at 850 nm (fibre-optic systems)
- $\leq 5$   $\mu\text{W}$  at 660 nm (polymer fibre systems)

### Influence of temperature and aging of LED, temperature dependence of the cable attenuation

These factors should be considered in the power balance using a value of 2 dB as the "excess loss", so that a total value of 5 dB must be used as the "system reserve".

## 2.2 Calculation examples

### a) Fibre-optic system ( $\lambda = 850 \text{ nm}$ )



\* Coupling attenuation at the transmitter/receiver are not considered separately, since they are already included in the output data for  $T_X$  and  $R_X$ .

### Power balance

Transmitter:

$$P_1 = 80 \mu\text{W} = -11 \text{ dBm}$$

power coupled into fibre core

$$\text{Fibre loss: } 2.5 \text{ km} \times 3 \text{ dB/km} = 7.5 \text{ dB}$$

$$\text{ST connector} = 0.8 \text{ dB}$$

$$\text{System reserve (3 dB + 2 dB)} = 5.0 \text{ dB}$$

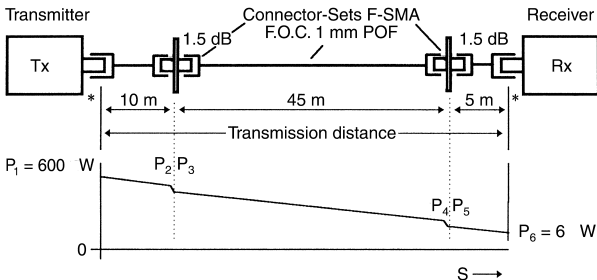
$$\text{Total system losses:} = 13.3 \text{ dB}$$

Receiver:

$$P_4 = -24.3 \text{ dBm} = 3.7 \mu\text{W}$$

Minimum value  $\geq 3 \mu\text{W}$  is fulfilled.

### b) Polymer fibre system ( $\lambda = 660 \text{ nm}$ )



### Power balance

Transmitter:

$P_1 = 600 \mu\text{W} = -2.2 \text{ dBm}$  in the power coupled fibre

- Fibre attenuation:  $60 \text{ m} \times 0.2 \text{ dB/m}$  = 12 dB
- F-SMA connector (2 x 1.5 dB) = 3.0 dB
- System reserve (3 dB + 2 dB) = 5.0 dB
- Total: 20.0 dB

XII

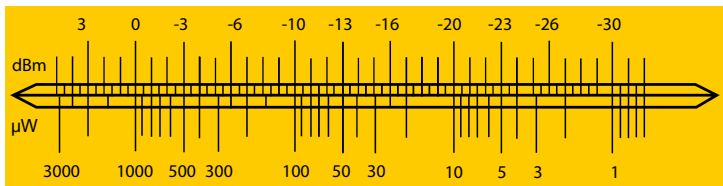
Receiver:

$P_6 = -22.2 \text{ dBm} = 6.0 \mu\text{W}$

Minimum value  $\geq 5 \mu\text{W}$  is fulfilled.

If the additional splitting points in the optical cable can be omitted (2 F-SMA connectors here), the resulting range in terms of distances would be larger.

### Conversion scale



### 3. Assembly of fibre optic connectors

The following pages describe the assembly of the fibre optic connectors used at HARTING.

Caution: It is absolutely essential to always wear appropriate protective clothing and goggles when working with open optical fibres.

#### 3.1 F-SMA connector for 1 mm POF with 2.2 mm cable sheath

**Part numbers:**

20 10 001 1211 (with hexagon fitting nut)

20 10 001 1213 (with knurled fitting nut)

XII

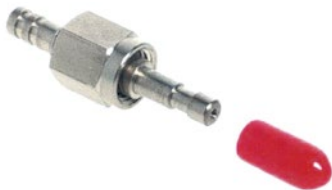
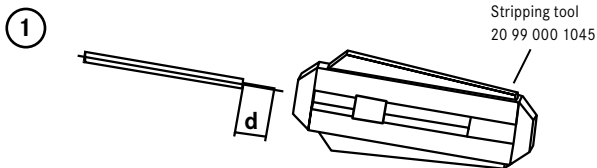


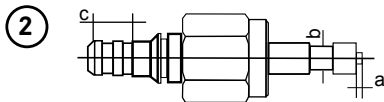
Figure VII-2: F-SMA connector for 1 mm POF

**Assembly**

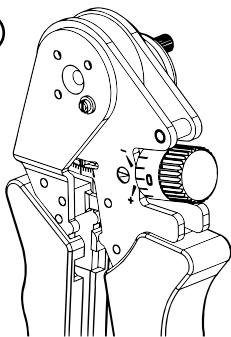
- Strip the fibre optic cable to a length of 8 mm (d).



- Attach the connector to the cable. With the cable completely inserted, the fibre should protrude about 1 mm (a) out of the connector tip.

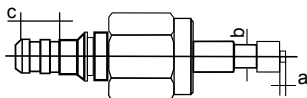


3



Four-indent crimp tool  
20 99 000 1035

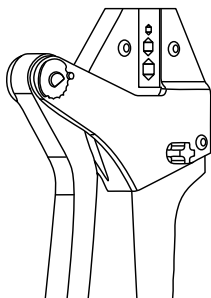
3. Use the four-indent crimp tool to crimp the FO fibre in the designated area of the contact tip (b). Set the crimp die with crimp tool closed:  $\varnothing$  2.0 mm locator setting 3 (refer to the operating instructions for the four-indent crimp tool).



4. Crimp the FO cable sheath using the FO crimp tool (hexagon SW 3 mm, see ) with the wiring range of the contact to a length of 4 mm (c).

5. Using the grinding and polishing block, polish the protruding fibre on a lapping film with grain size 1000 and a hard surface, e.g. glass plate. The contact face can be repolished with a polishing paper 9 $\mu$ -grit.

4



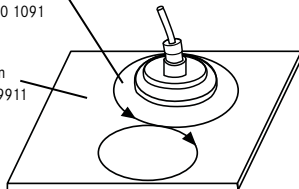
HARTING crimp tool  
for FO connectors  
20 99 000 1033

6. Check the quality of the face with a microscope at 30x magnification.

5

Grinding and polishing  
block  
20 99 000 1091

Lapping film  
20 80 001 9911





### 3.2 F-SMA connectors for 1 mm POF with 3.6 mm cable sheath

Part numbers:

20 10 001 1241 (with hexagon nut)

20 10 001 1243 (with knurled nut)

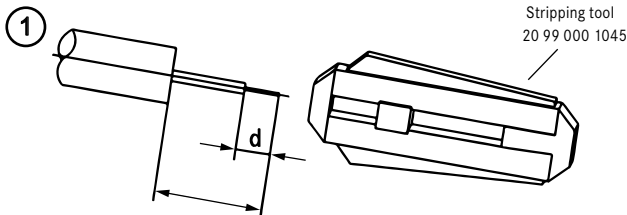


XII

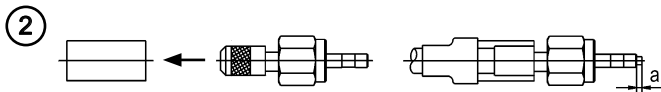
Figure VII-3: F-SMA for 3.6 mm SERCOS cable

#### Assembly

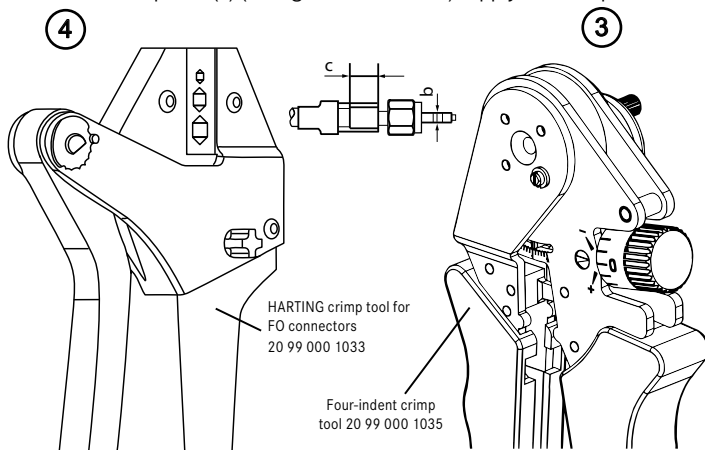
- Strip the FO cable to a length of 25 mm (l). The strain relief (Kevlar) is cut along the entire length. Strip the cable sheath of the fibre to a length of 8 mm (d).



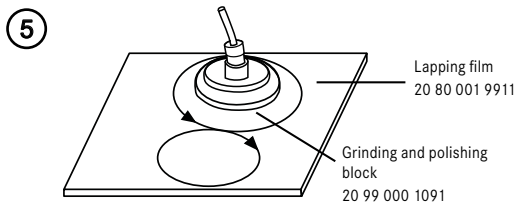
- Put on the bend protection and the crimp barrel on the cable. Push the connector with the cable side about 6 mm under the outer cable sheath. With the cable completely inserted, the fibre should protrude about 1 mm out of the connector tip (a).



3. Use the four-indent crimp tool to crimp the FO fibre in the designated area of the contact tip (b). Setting the crimp die with crimp tool closed:  $\varnothing$  2.0 mm locator setting 3 (see operating instructions of four-indent crimp tool).
4. Slide the crimp barrel over the strain relief and crimp the FO cable using the FO crimp tool (c) (hexagon SW 4.95 mm). Apply the crimp tool twice.



5. Using the grinding and polishing block, polish the protruding fibre on a lapping film with 1000-grit and a hard surface, e.g. glass plate. The contact face can be repolished with a polishing paper 9 $\mu$ -grit.



6. Check the quality of the face with a microscope at 30x magnification.
7. Push the cable bend protector over the crimp barrel.

### 3.3 F-SMA connectors for 1 mm POF with 6 mm cable sheath

Part numbers:

20 10 001 1221 (with hexagon nut)

20 10 001 1223 (with knurled nut)



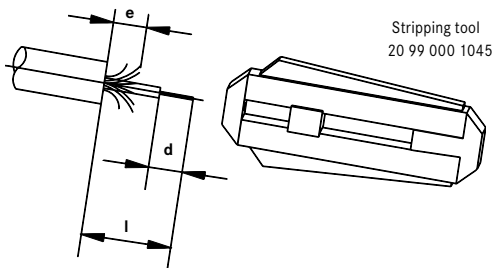
XII

Figure VII-4: F-SMA for 6 mm SERCOS cable

#### Assembly

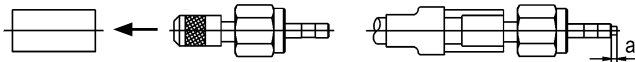
- Strip the FO cable to a length of 32 mm (l). The strain relief (Kevlar) is cut along 8 mm (e). Strip the cable sheath of the fibre to a length of 8 mm (d).

①



- Put on the bend protection and the crimp barrel on the cable. With the cable completely inserted, the fibre should protrude about 1 mm out of the connector tip (a).

②

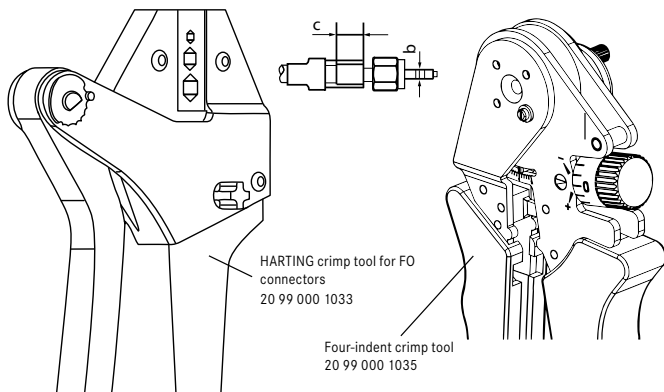


Use the FO Buchanan crimp tool to crimp the FO fibre in the designated area of the contact tip (b). Setting with crimp tool closed:  $\varnothing$  2.0 mm.

4. Push the crimp barrel over the strain relief and crimp the FO cable using the HARTING crimp tool (c) (hexagon 6.5 mm). Apply the crimp tool twice.

④

③

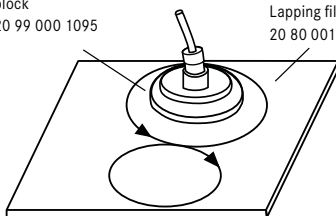


5. Using the grinding and polishing block, polish the protruding fibre on a lapping film with 1000-grit and a hard surface, e.g. glass plate. The contact face can be repolished with a polishing paper 9 $\mu$ -grit.

⑤

Grinding and polishing  
block  
20 99 000 1095

Lapping film  
20 80 001 9911



6. Check the quality of the face with a microscope at 30x magnification.
7. Use a heat source to shrink the shrink tube over the crimping position.

### 3.4 Quick-assembly connectors for 1 mm POF with 2.2 mm cable sheath

**Part numbers:**

- 20 10 001 1212 F-SMA with hexagon nut
- 20 10 001 1215 F-SMA with knurled nut
- 20 10 001 1217 F-SMA with knurled nut and cable bend protector
- 20 10 001 2212 FH-ST
- 20 10 001 5217 SC contact
- 20 10 001 5218 SC contact with bend protector

XII

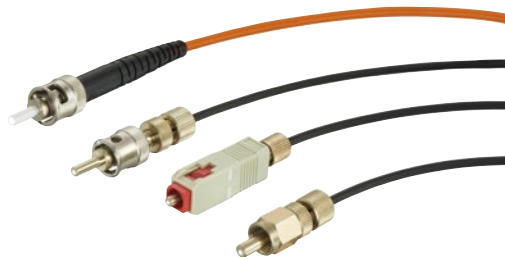
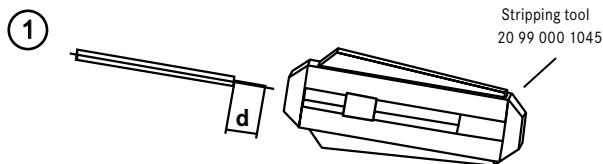


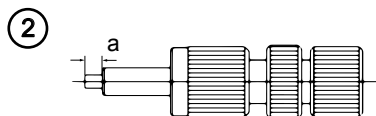
Figure VII-5: F-SMA and FH-ST connectors, SC contact (2<sup>nd</sup> f.r.)

**Assembly**

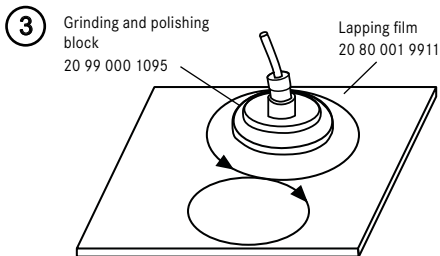
1. Strip the FO cable to a length of 0 mm (d).



2. Position the connector on the cable. With the cable completely inserted, the fibre should protrude about 1 mm (a) out of the connector tip. Fix the cable by tightening the knurled nut.



3. Using the grinding and polishing block, polish the protruding fibre on a lapping film with 1000-grit and a hard surface, e.g. glass plate. The contact face can be re-polished with a polishing paper 9 $\mu$ -grit.



XII

### 3.5 FH-ST connectors for 1 mm POF with 2.2 mm cable sheath

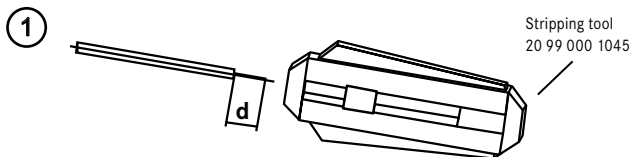
Part number: 20 10 001 2211



Figure XII-7: FH-ST connectors

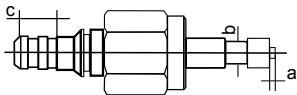
#### Assembly

1. Strip the FO cable to a length of 10 mm (d).



- Position the connector on the cable. With the cable completely inserted, the fibre should protrude about 1 mm (a) out of the connector tip.

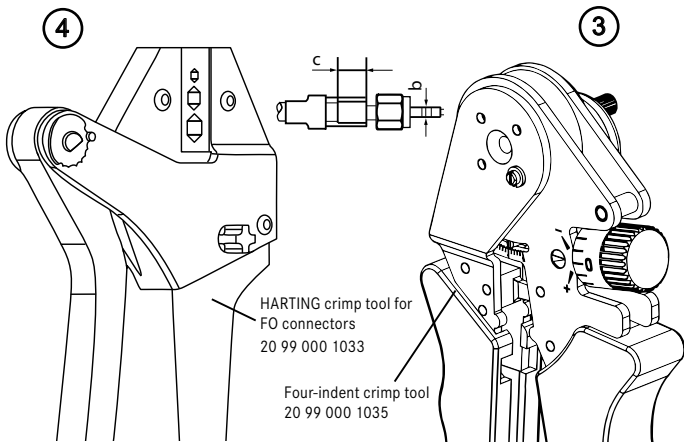
2



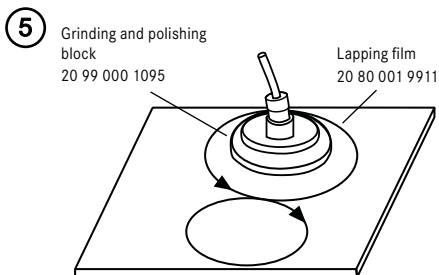
- Use the four-indent crimp tool to crimp the FO fibre in the designated area of the contact tip (b). Setting the crimp die with crimp tool closed:  $\varnothing$  2.0 mm locator setting 3 (see operating instructions of four-indent crimp tool).

XII

- Crimp the FO cable sheath using the FO crimp tool (hexagon SW 3 mm) with the wiring range of the contact to a length of 4 mm (c) .



- Using the grinding and polishing block, polish the protruding fibre on a lapping film with 1000-grit and a hard surface, e.g. glass plate. The contact face can be repolished with a polishing paper 9 $\mu$ -grit.



XII

6. Check the quality of the face with a microscope at 30x magnification.

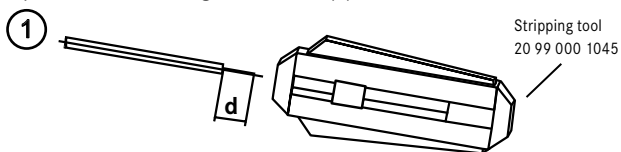
### 3.6 FO cable end sleeve for 1 mm POF with 2.2 mm cable sheath

Part number: 20 10 001 3232

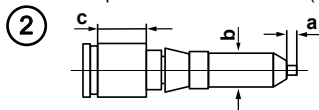


#### Assembly

1. Strip the cable to a length of 11 mm (d).

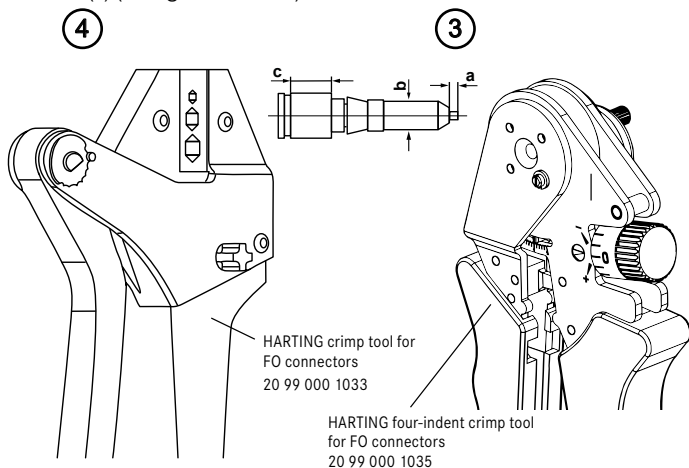


2. Position the contact on the cable. With the cable completely inserted, the fibre should protrude about 1 mm (a) out of the connector tip.



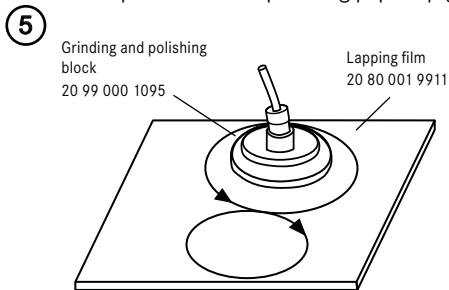


- Use the FO Buchanan crimp tool to crimp the FO fibre in the designated area of the contact tip. Setting with crimp tool closed:  $\varnothing$  1.8 mm (b).
- Crimp the FO cable sheath using the HARTING crimp tool over a length of 3 mm (c) (hexagon SW 3 mm).



XII

- Using the grinding and polishing block, polish the protruding fibre on a lapping film with 1000-grit and a hard surface, e.g. glass plate. The contact face can be repolished with a polishing paper 9 $\mu$ -grit.



- Check the quality of the face with a microscope at 30x magnification.

### 3.7 F-TNC connectors (female)

Part number: 20 10 001 6233

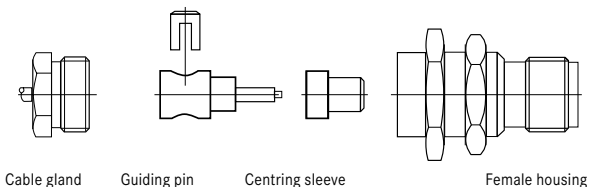
This connector is designed for 1 mm *POF* with 2.2 mm cable sheath.



XII

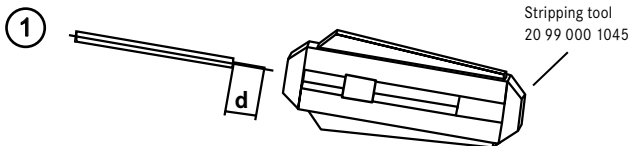
Figure XII-9: F-TNC female

#### Description:

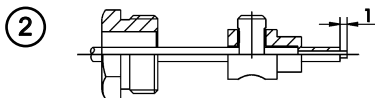


#### Assembly

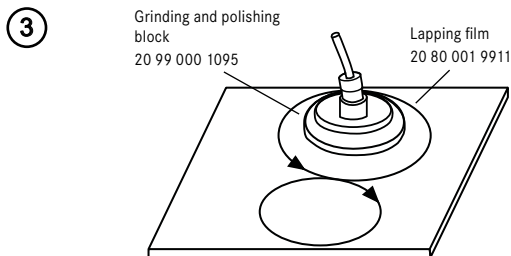
- Strip the FO cable to a length of 7 mm (d).



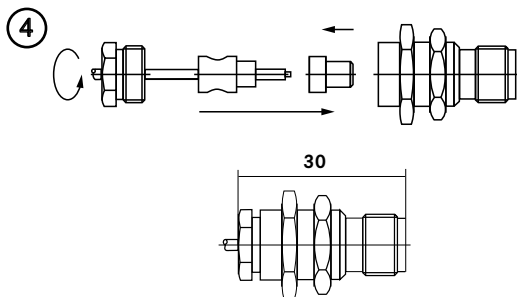
- Push cable gland over cable, position the guiding pin fully on the stripped cable. With the cable completely inserted, the fibre should protrude about 1 mm out of the guiding pin. To fix the cable in place, insert the clip in the hole and press on to the cable.



- Using the grinding and polishing block (5.5 mm thickness), polish the protruding fibre on a lapping film with 1000-grit and a hard surface, e.g. glass plate. The contact face can be repolished with a polishing paper 9 $\mu$ -grit.



- For final assembly, the centring sleeve is placed on the guiding pin and inserted into the female housing. The cable gland is tightened.



### 3.8 F-TNC connector (male)

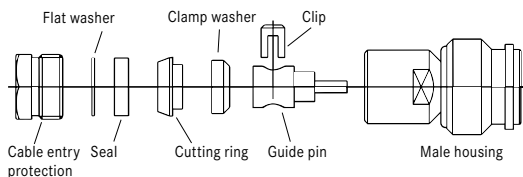
Part number: 20 10 001 6211

This connector is designed for 1 mm *POF* with 5.5 to 6.0 mm cable sheath.



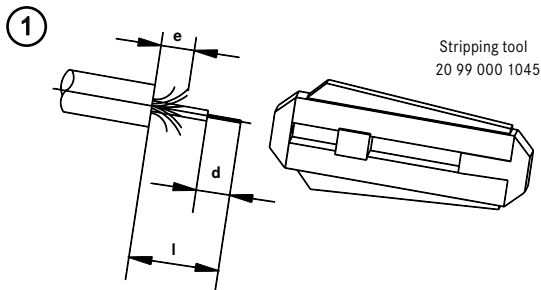
XII Figure XII-10: F-BNC male

#### Description:

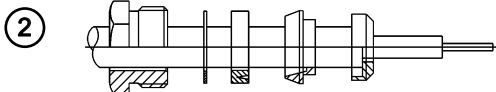


#### Assembly

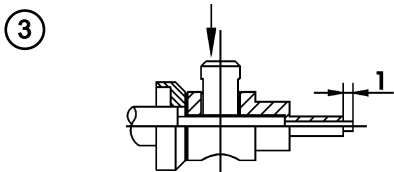
1. Use a cable knife to strip the FO cable to a length of 18 mm (L). Strip the strain relief (Kevlar) to a length of 7 mm (e). Strip the FO fibre cladding to a length of 7 mm (d).



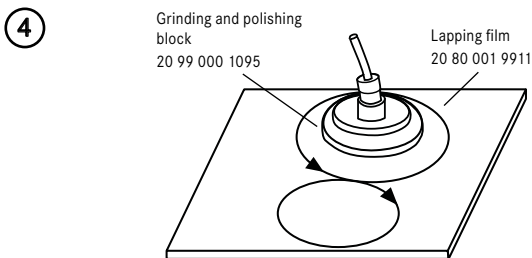
2. Push the cable gland, flat washer, seal, cutting ring over the cable sheath. Push the clamp washer over the fibre cladding.



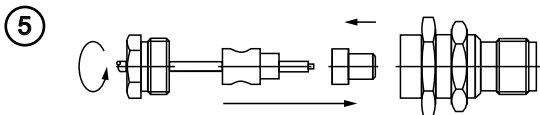
3. Put the guiding pin on the fibre until it stops. To secure the position, press the clip over the cable sheath into the guiding pin. With the cable completely inserted, the fibre should protrude about 1 mm out of the guiding pin.



4. Using the grinding and polishing block (5.5 mm thickness), polish the protruding fibre on a lapping film with 1000-grit and a hard surface, e.g. glass plate. If necessary, repolish the contact face with a 9µ grit polishing paper.



5. Clamp the Kevlar between clamp washer and cutting ring for final assembly. Slide the seal, flat washer and cable gland to the cutting ring. Attach the male housing and tighten the cable gland firmly.



### 3.9 F-ST connectors for glas fibre

Part number: 20 10 125 2212

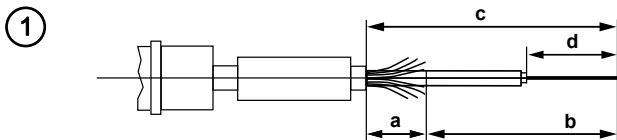
XII



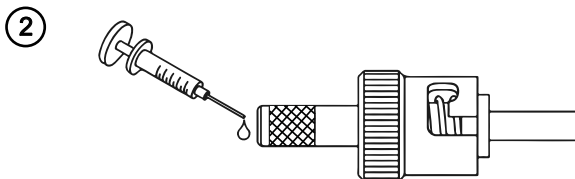
Figure VII-6: F-ST fibre optic connector

#### Assembly

- Slide the bend protection and the crimp barrel on the cable. Strip the outer sheath to a length of 47 mm (c). Strip the strain relief to a length of 7 mm (a). Strip the compact wire to a length of 40 mm (b). Strip the primary protective layer of the fibre to a length of 28 mm (d).

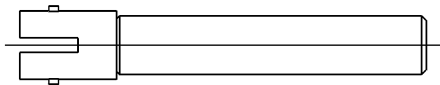


- Using a 1-ml syringe, inject 1.5 to 2 increments of adhesive into the connector. Clean fibre with alcohol. Insert fibre with cable into the connector. If necessary, turn this slightly. Push the crimp barrel onto the connector and crimp it with the crimp tool (20 99 000 1031).



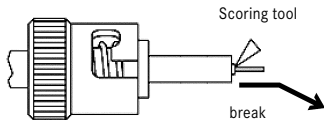
- Mate the F-ST heating box adapter onto the connector.  
Allow to harden for about 1/2 hour in the heating box.

3



- Then, score the fibre carefully with a scoring tool. The protruding fibre is broken under tension and slight bending.

4

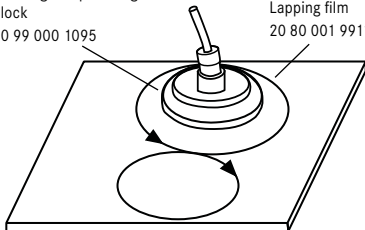


- Using a grinding and polishing block, the contact face is polished on polishing paper with 9 $\mu$ -grit and then repolished with polishing paper with 1 $\mu$ -grit.

5

Grinding and polishing  
block  
20 99 000 1095

Lapping film  
20 80 001 9911



- Check the quality of the face with a microscope at 200x magnification.

XII

### 3.10 SC contacts for glass fibre

Part number: 20 10 125 5211

These contacts are designed for interior cabling 50/125  $\mu\text{m}$  and 62.5/125  $\mu\text{m}$  with 2.8 mm cable sheaths. After assembly, this contact can be assembled in the SC module from the Han-Modular® series or in the SC insert for the housing of size Han® 3 A.

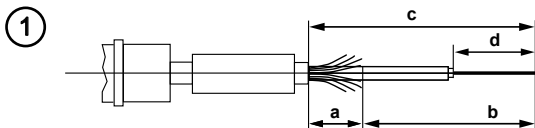
XII



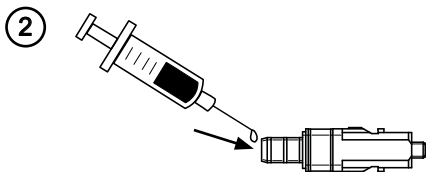
Figure XII-15: SC contact

#### Assembly

- Slide the bend protection and the crimp barrel on the cable. Strip the outer sheath to a length of 48 mm (c). Strip the strain relief to a length of 8 mm (a). Strip the compact wire to a length of 40 mm (b). Strip the primary protective layer of the fibre to a length of 29 mm (d).

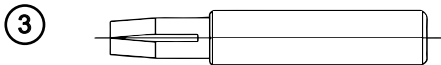


- Using a 1-ml syringe, inject 1.5 to 2 increments of adhesive into the connector. Clean fibre with alcohol. Insert fibre with cable into the connector. If necessary, turn this slightly. Push the crimp barrel onto the connector and crimp it with the crimp tool (20 99 000 1031).

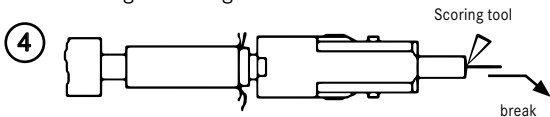




- Mate the SC heating box adapter onto the connector. Allow the connectors to harden for about 1/2 hour in the heating box.

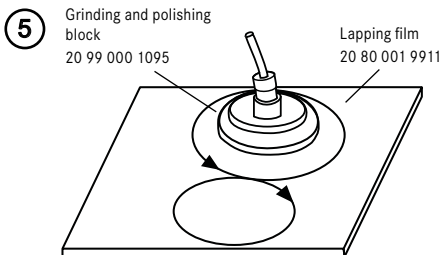


- Then, score the fibre carefully with a scoring tool. The fibre is broken under tension and slight bending.



XII

- Using a grinding and polishing block, the contact face is polished on a polishing paper with 9 $\mu$ -grit and then repolished with polishing paper with 1 $\mu$ -grit.



- Check the quality of the face with a microscope at 200x magnification.

### 3.11 LC contact for GI fibre and single mode fibres

Part numbers: 20 10 125 8211

20 10 125 8212

20 10 125 8220

20 10 125 8221

The LC contact is suitable for FO inside cables 50/125  $\mu\text{m}$  and 62.5/125  $\mu\text{m}$  with 2.8 or 3.0 mm cable sheath.

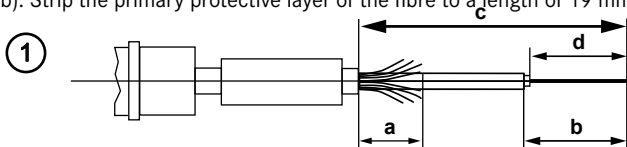
XII



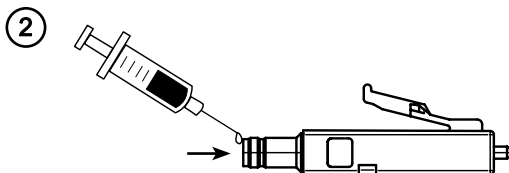
Figure XII-16. LC contact

#### Assembly

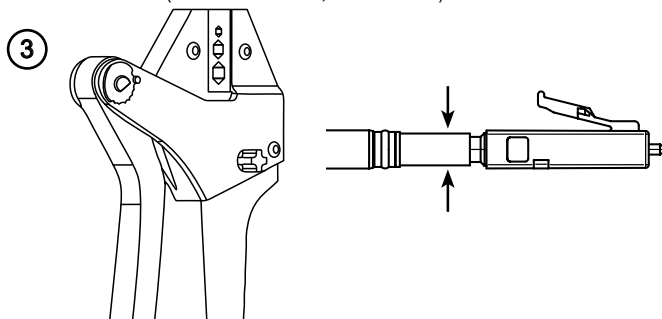
- Slide the bend protection and the crimp barrel on the cable. Strip the outer sheath to a length of 40 mm (c). Strip the strain relief to a length of 6.5 mm (a). Strip the secondary protective layer of the fibre to a length of 20 mm (b). Strip the primary protective layer of the fibre to a length of 19 mm (d).



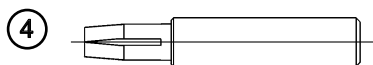
- Mate the heating box adapter onto the connector. Using a 1-ml syringe, inject 1.5 to 2 increments of adhesive into the connector. Clean fibre with alcohol. Insert fibre with cable into the connector. If necessary, slightly turn the connector.



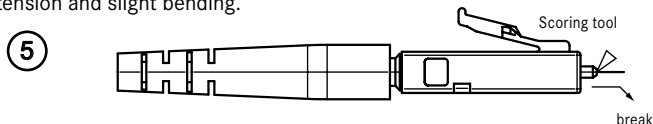
3. Push the crimp barrel onto the connector and crimp it with the crimp tool for FO connectors (20 99 000 1031, SW 3.2 mm).



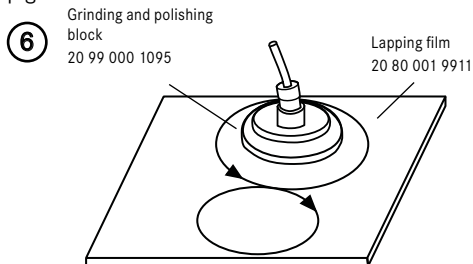
4. Allow the connectors to harden for about 1/2 hour in the heating box.



5. Then, score the fibre carefully with a scoring tool. The fibre is broken under tension and slight bending.



6. Using a grinding and polishing block, the contact face is polished on a polishing paper with 9 $\mu$ -grit and then repolished with polishing paper with 1 $\mu$ -grit.



7. Check the quality of the face with a microscope at 200x magnification.

## 4. FO contacts

The following pages describe the assembly of the FO contacts used at HARTING. The FO contacts lock into the insert after assembly. Therefore, both electrical and optical contacts can be used in a connector.

### 4.1 FO contacts for Han D® and Han DD® contact inserts

#### Part numbers:

20 10 001 32x1 for insert Han® R 15 and Han DD®

20 10 001 32x2 for insert Han® U and Han D®

20 10 001 32x3 for insert Han® 15D to Han® 25D

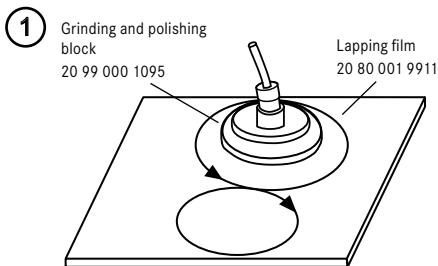
This FO contact is designed for 1 mm *POF* wire with 2.2 mm cable sheath.



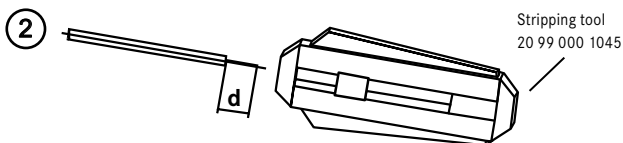
Figure XII-11: FO contacts for Han D® and Han DD®

#### Assembly

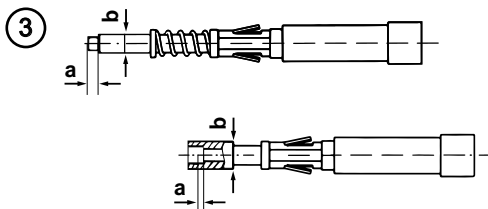
- Optical fibre end face must be polished before the crimping the contacts. A polish tool and lapping film must be used with 1000-grit. A hard surface, e.g. a glass plate is best suited for this purpose. The fibre end face can be polished with a polishing paper 9µ grit.



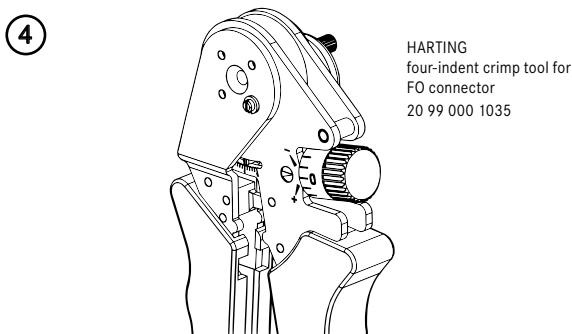
- Strip the FO cable to a length of 14 mm for the female contact and 19 for the male contact (d).



- Position the contacts on the cable. With the cable completely inserted, the fibre should protrude about 1 mm out of the contact (a).



- Use the four-indent crimp tool to crimp the FO fibre in the designated area of the contact tip (b). Setting the crimp die with crimp tool closed for the male contact:  $\varnothing$  1.48 mm for locator setting 1. For the female contact:  $\varnothing$  1.48 mm for locator setting 2 (see operating instructions for the four-indent crimp tool). For the male contact, the fibre must be flush with the male tip, and for the female contact, it must terminate with the female earth.



## 4.2 FO contacts for Han E® inserts

Part number: 20 10 001 33x1

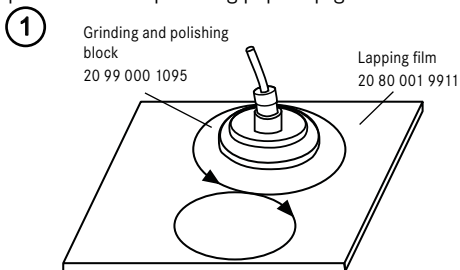
These FO contacts are designed for 1 mm *POF* wire with 2.2 mm cable sheath.



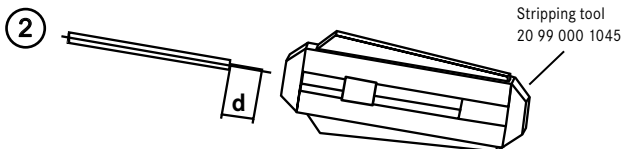
XII

Figure XII-12: FO contact for Han E®

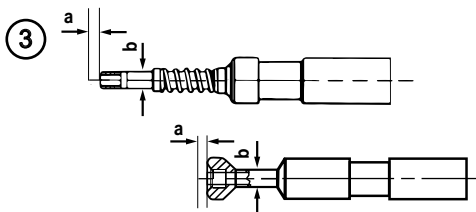
- Optical fibre end face must be polished before the crimping the contacts. A polish tool and lapping film must be used with 1000-grit. A hard surface, e.g. a glass plate is best suited for this purpose. The contact face can be repolished with a polishing paper 9 $\mu$ -grit.



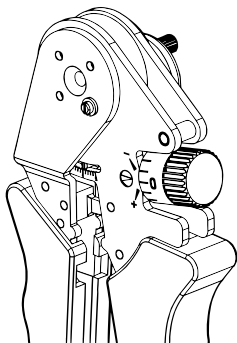
- Strip the FO cable to a length of 8 mm for the female contact and 19 mm for the male contact (d).



3. Position the contacts on the cable. With the cable completely inserted, the fibre should protrude about 1 mm out of the contact (a).



4. Use the four-indent crimp tool to crimp the FO fibre in the designated area of the contact tip (b). Setting the crimp die with crimp tool closed for the male contact:  $\varnothing$  1.48 mm for locator setting 1. For the female contact:  $\varnothing$  1.48 mm for locator setting 2 (see operating instructions for the four-indent crimp tool). For the male contact, the fibre must be flush with the male tip. For the female contact, it must terminate with the female earth.

**4**

HARTING  
Four-indent crimp tool for FO  
connector  
20 99 000 1035

### 4.3 FO contacts for 1 mm POF in Han-Modular®

Part numbers:

20 10 001 4211

20 10 001 4221

These FO contacts are designed according to CECC 78 001-801 (formerly DIN 41 626, Part 3) for 1 mm POF with 2.2 mm cable sheath.

XII

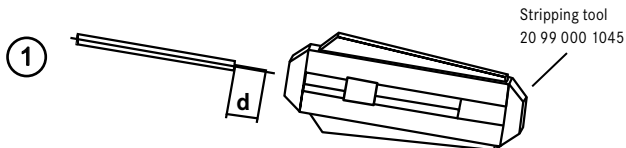


Figure XII-13: FO contacts Han-Modular®

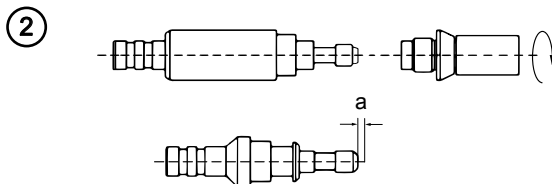
#### Assembly

**FO contacts for single wire cable for mixed loading of connectors in accordance with DIN 41 612 (Gds A-M)/DIN 41 652 (D-Sub)**

- Strip the FO fibre from the cable sheath. The *stripping length* for a male contact is at least 9 mm (d), for the female contact, it is at least 13 mm (d).

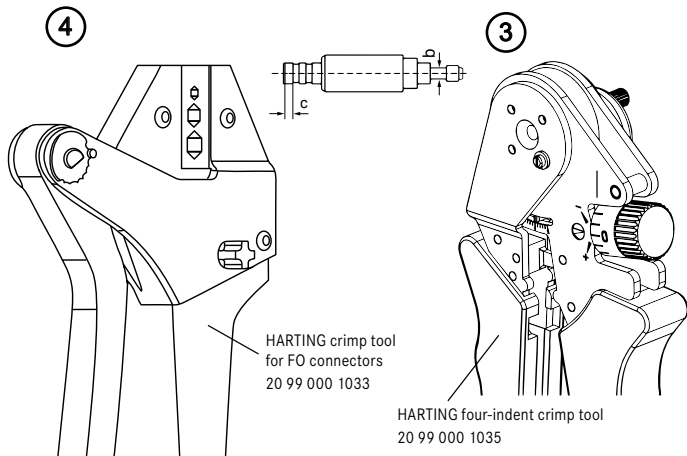


- Unscrew the female insert from the barrel. Position the contact on the cable. With the cable completely inserted, the fibre should protrude about 1 mm (a) out of the contact tip.

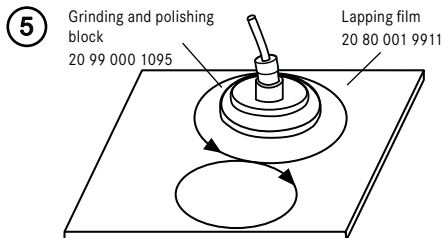




- Use the four-indent crimp tool to crimp the FO fibre on the contact tip (b). Setting the crimp die with crimp tool closed:  $\varnothing$  1.8 mm, locator setting 3 (see operating instructions of four-indent crimp tool).
- Crimp the FO contact using the FO crimp tool (hexagon SW 3 mm) in the cable entry portion of the contact (c) over a length of approx. 4 mm.



- Using the grinding and polishing block (7 mm thickness), polish the protruding fibre on a lapping film with grain size 1000 and a hard surface, e.g. glass plate. The contact face can be repolished with a polishing paper 9 $\mu$ -grit.



- Screw the barrel on the female insert. Pay attention to the position of the locking ring!

#### 4.4 FO contacts for GI fibre in Han-Modular®

These contacts are designed for indoor cable 50/125  $\mu\text{m}$  and 62.5/125  $\mu\text{m}$  with 2.8 mm cable sheath for assembly in the multi-contact module of the Han-Modular® series, using the following Insulator:

##### Part numbers:

20 10 125 4212/20 10 125 4222

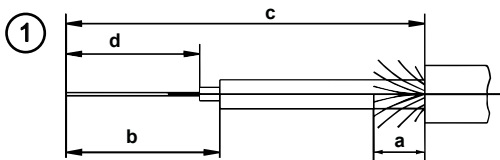
XII



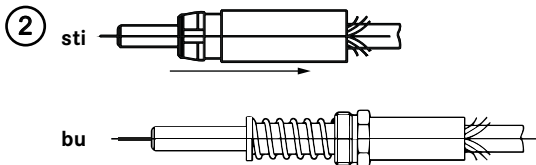
Figure XII-14: Fibre-optic contacts for Han-Modular®

##### Assembly:

- Strip the outer sheath to a length of 22 mm (sti) and 32 mm (bu) (c). Strip the strain relief to a length of 5 mm (a). Strip the secondary protective layer to a length of 20 mm (b), strip the primary protective layer of the fibre to a length of 18 mm (d). The stripping length is the same for male and female.



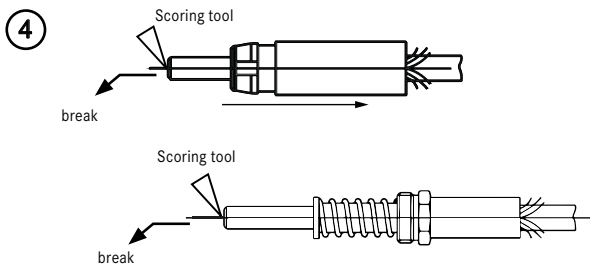
- Mate the F-ST heating box adapter onto the connector. Using a 1-ml syringe, inject 1.5 to 2 increments of adhesive into the connector. Clean fibre with alcohol. Apply adhesive to the strain relief (Kevlar fibre). Insert fibre with cable into the connector. If necessary, turn this slightly.



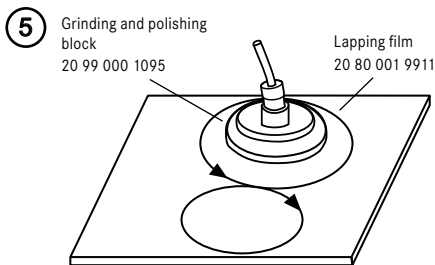
3. Allow the connectors to harden for about 1/2 hour in the heating box.



4. Then, score the fibre carefully with a scoring tool. The protruding fibre is broken under tension and slight bending.

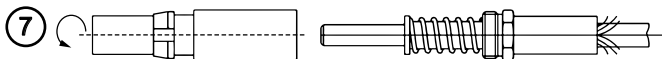


5. Using a grinding and polishing block, the contact face is polished on a polishing paper with 9 $\mu$ -grit and then repolished with polishing paper with 1 $\mu$ -grit.



6. Check the quality of the face with a microscope at 200x magnification.

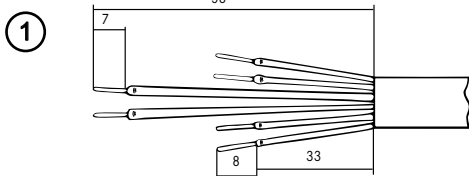
7. The barrel is then screwed on the female insert.



## 4.5 Han-Brid® FO contacts

### Assembly

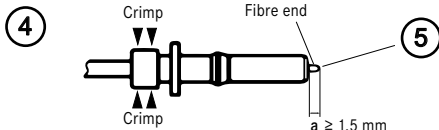
1. Dismantle and strip the cable according to the drawing. The stripped lengths of the two FO wires must be identical.



2. Crimp the electrical contacts. The crimp tool 09 99 000 0362 is designed for application of twisted HARTING crimp contacts with cross-section  $1.5 \text{ mm}^2$  and Hewlett Packard versatile Link FO crimp contacts.
3. Carefully push the crimp ring on the optical contact, so that it is flush with the contact end and there is a gap between crimp ring and contact flange. Push optical contacts fully on the FO fibre.



4. Fix the crimp ring using the Han Brid® crimp tool.



5. Shorten the protruding fibre end on the FO contact to a length of 1.5 mm. Polish the fibre end of the FO contacts with 600-grit lapping film and a polishing wheel. Polishing set part no.: 20 80 0001 9914.
6. The polishing process is finished when the face of the contact end is flush with the polishing fixture. Clean the contact end with a soft, lint-free cloth.

### Crimping process

1. Check that the wire is stripped properly according to the assembly instructions, point ①.
2. Insert the contact into the crimp profile intended for the core type.
3. Use of the positioner the Han D® contact is locked properly.
4. Insert a stripped wire into the contact.
5. Crimp until the tool opens again.
6. Take out the crimped contact.

## 5. HARTING four-indent crimp tool operating instructions for 1 mm POF contacts

Part number: 20 99 000 1035

### General

The HARTING four-indent crimp tool for FO is a crimp tool, manufactured according to the latest state-of-the-art and the recognized safety regulations. The hand crimp tool may only be used when functioning perfectly.

The crimp tool is used for crimping turned fibre optic contacts. The crimp tool must only be used for the purpose described in the operating instructions. The manufacturer is precluded from liability for damages that result from unauthorized alterations or improper use of this hand crimp tool.

XII

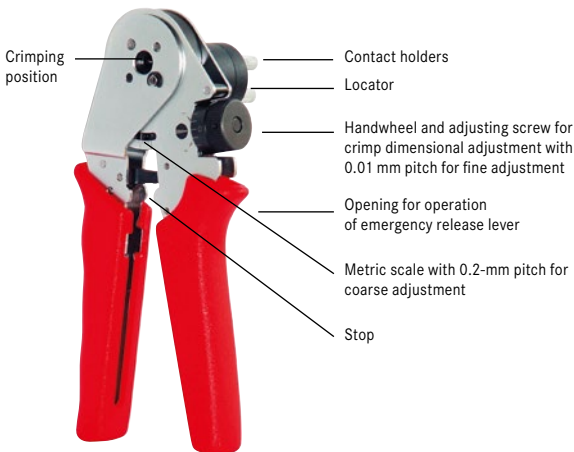


Figure XII-16: Four-indent crimp tool

### Operation sequence

1. Crimp dimensional and locator setting for the contact to be crimped can be found in Table XII-1, p. 235.
2. The crimp dimension adjustment (crimp depth of the crimp pins) on control device.
3. Move locator bring by lateral lifting in the set, according to Matrix position. **Ensure that the contact holders are not pressed in and locked.**
4. Press in the contact holder in the locator and lock by rotating through 90°.

5. Insert the FO contacts in the crimping position until it stops and close the crimp tool to the first locking step.
6. Insert the prepared cable into the FO contact in the crimp tool until it stops, apply light pressure to cable and connector against the stop and close crimp tool.
7. Remove the crimped FO contact from the crimp tool.
8. When selecting a new locator position, first unlock the contact holder and move to the starting position before making the new setting.

## XII Crimp dimensional adjustment

The crimp dimensional adjustment (crimp depth of the crimp pins) is made as follows using the control device (using the adjusting wheel and adjusting screw).

### Infeed movements

- clockwise = reducing the crimp dimension
- counterclockwise = increasing the crimp dimension

### Infeed accuracy

- 1 increment on the adjusting wheel = 0.01 mm infeed
- 1 turn of the adjusting wheel = 0.2 mm infeed, can be read on the adjusting wheel
- 5 turns of the adjusting wheel = 1 mm infeed, read on the scale

### Crimp dimensional check

The four-indent crimp tool is preset at the factory. Nevertheless, you should check the crimp dimension regularly. Please fill the plug gauge  $\varnothing$  2.0 mm (included with four-indent crimp tool) as described below.

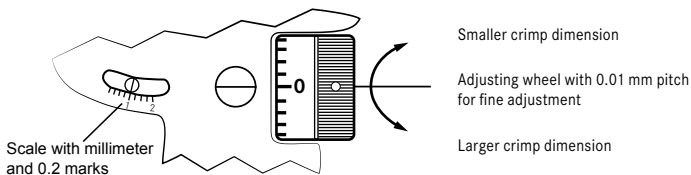


Figure XII-17: Crimp dimensional adjustment

Use the adjusting wheel to adjust the dimension 2.0 mm on the scale of the fixed handle. The pitch on the adjusting wheel is set to zero and the crimp tool is closed (see Figure XII-17, p. 236). With this setting, the plug gauge  $\varnothing$  2.0 mm must be able to move between the crimp pins without play.

If this is not the case, the fine adjustment of the rotary control can be used to determine the dimensional change (+/-) (to be applied as a micrometer screw). If, when checking the crimp, the four-indent crimp tool is outside the tolerance of  $\pm 0.06$  mm, the crimp tool manufacturer should be contacted for examination.

Table XII-1: Adjustment recommendations

Type	Part no.	Locator setting	Crimp pin infeed
FO male insert 1 mm/2.2 mm POF for Han DD®, Han® K	20 10 001 3211	1	1.48 mm
FO male insert 1 mm/2.2 mm POF for Han D®, Han® U	20 10 001 3212	1	1.48 mm
FO male insert 1 mm/2.2 mm POF for Han E®	20 10 001 3311 20 10 001 3213	1 1	1.48 mm 1.48 mm
FO female insert 1 mm/2.2 mm POF for Han DD®, Han® K	20 10 001 3221	2	1.48 mm
FO female insert 1 mm/2.2 mm POF for Han D®, Han® U	20 10 001 3222	2	1.48 mm
FO female insert 1 mm/2.2 mm POF for Han E®	20 10 001 3321	2	1.48 mm
Fo cable end sleeve 1 mm/2.2 mm POF	20 10 001 3232	3	1.80 mm
FO male insert 1 mm/2.2 mm POF for Han® Multi Module	20 10 001 4211	3	1.80 mm
FO female insert 1 mm/2.2 mm POF for Han® Multi Module	20 10 001 4221	3	1.80 mm
FH-ST connector 1 mm/2.2 mm POF	20 10 001 2211	3	2.0 mm
F-SMA connector 1 mm	20 10 001 1211	3	2.0 mm
F-SMA connector 1 mm	20 10 001 1221	3	2.0 mm
F-SMA connector 1 mm	20 10 001 1223	3	2.0 mm
F-SMA connector 1 mm	20 10 001 1241	3	2.0 mm
F-SMA connector 1 mm	20 10 001 1243	3	2.0 mm

## 6. Tool kit

The tools of the HARTING FO tool kit are for assembling FO connectors on-site.

The specially arranged tools for the type of assembly and design of the fibre are tried and proven in practice. Detailed instructions for the assembly of different connectors are included with the assembly kit.

XII

### 6.1 POF assembly kit with optical measuring devices

Part number: 20 99 000 3013



Depth: 360 mm  
Width: 470 mm  
Height: 170 mm

Figure XII-19. Assembly kit 20 99 000 3013

The tools can be used to assemble FO connectors of the type F-SMA, ST and other FO contacts without gluing and polishing. The easy-to-handle measuring devices are intended for servicing purposes and checking the optical path. The assembly kit contains the complete set of tools and measuring devices required for assembly work.

#### The kit contains

Lower tray:

1. Documentation
2. Dry sanding paper, grit 1000 .....20 80 001 99 11
3. Optical wattmeter OPM-1D
4. Adapter cable POF 1/2.2 F-ST/F-SMA
5. Adapter cable POF 1/2.2 F-ST/F-ST
6. Adapter cable POF 1/2.2 F-ST/F-SC
7. Adapter cable POF 1/2.2 F-ST/DIN 41626 female
8. Adapter cable POF 1/2.2 F-ST/DIN 41626 male
9. Adapter cable POF 1/2.2 F-ST/Han D female



10. Adapter cable POF 1/2.2 F-ST/Han D male
11. Adapter cable POF 1/2.2 F-ST/Han E female
12. Adapter cable POF 1/2.2 F-ST/Han E male

## Upper tray:

13. FO crimp tool for 1 mm POF .....20 99 000 1035
14. FO crimp tool POF/SERCOS .....20 99 000 1033
15. Stripping tool
16. Combi-shears (all-purpose shears)
17. FO grinding surface, glass
18. Hinge box
  - a. F-ST adapter for OPM
  - b. Polish tool F-SMA .....20 99 000 1091
  - c. Polish tool DIN 41626 .....20 99 000 1092
  - d. Polish tool POF cable 2.2.....20 99 000 1093
  - e. Polish tool F-ST.....20 99 000 1095
  - f. Polish tool F-SC POF.....20 99 000 1099
  - g. Polish tool for cable end sleeve .....20 99 000 1096
  - h. POF Schneidwerkzeug
  - i. F-SMA coupling .....20 80 000 1071
  - j. F-ST coupling.....20 80 000 1021
  - k. F-SC coupling
  - l. F-SMA microscope adapter
  - m. F-ST/F-SC microscope adapter
  - n. Precision stripper 1.0 POF.....20 99 000 1045
  - o. Universal cutter with plastic handle
19. Microscope 30x
20. Fibre checker 650 nm

The assembly and operating instructions on the following tools are included.

## 6.2 FO measuring device kit

Part number: 20 99 000 3014



Depth: 360 mm  
Width: 470 mm  
Height: 170 mm

XII

Figure XII-20: FO measuring device kit 20 99 000 3014

Measuring optical outputs and attenuations in plastic (POF) and fibre optic cables at a wavelength of 650 nm and 850 nm.

Included in delivery:

Measuring cable for:

- 50 / 125  $\mu\text{m}$  GI-fibre, 1 m
- 200 / 230  $\mu\text{m}$  SI-fibre, 1 m
- 1 mm plastic fibre, 2 m

Measuring device adapter for:

- F-SMA termination
- F-ST termination

### The kit contains

Lower tray:

1. Hinge box
  - a. F-ST adapter for OPM
  - b. F-LC adapter for OPM
  - c. Adapter 1.25 mm for fibre checker
  - d. F-SMA coupling
  - e. F-ST coupling
  - f. F-LC coupling
  - g. F-SC coupling
2. Optical wattmeter OPM-1D
3. Light source 850 nm
4. Fibre checker 650 nm
5. Adapter cable POF 1/2.2 F-ST/F-SMA
6. Adapter cable POF 1/2.2 F-ST/F-ST
7. Adapter cable POF 1/2.2 F-ST/F-SC
8. Adapter cable POF 1/2.2 F-ST/DIN 41626 female

9. Adapter cable POF 1/2.2 F-ST/DIN 41626 male
10. Adapter cable POF 1/2.2 F-ST/Han D female
11. Adapter cable POF 1/2.2 F-ST/Han D male
12. Adapter cable POF 1/2.2 F-ST/Han E female
13. Adapter cable POF 1/2.2 F-ST/Han E male

#### Upper tray:

14. One click cleaner 1.25 mm .....20 80 001 9920
15. One click cleaner 2.5 mm .....20 80 001 9921
16. Documentation
17. Adapter cable GI 50/125 F-LC/F-ST
18. Adapter cable GI 50/125 F-LC/DIN 41626 male
19. Adapter cable GI 50/125 F-LC/DIN 41626 female
20. Adapter cable GI 50/125 F-LC/F-SC
21. Adapter cable GI 50/125 F-LC/F-LC

XII

The assembly and operating instructions on the following tools are included.

### 6.3 GI-fibre assembly kit

**Part number: 20 99 000 3015**



Depth: 360 mm  
Width: 470 mm  
Height: 170 mm

*Figure XII-21. Assembly kit 20 99 000 3015*

Tool kit for assembling FO connectors of type F-SMA, F-ST, F-SC, F-LC and DIN 41626 to FO cable with graded index fibre in adhesive technology.

## The kit contains

### Lower tray:

1. Heating box 24x FO / 240 V
  - a. Thermometer
  - b. Mains cable
2. Spray bottle for alcohol
3. Residual fibre container
4. Microscope 200x incl. 1.25mm and 2.5mm adapter
5. Optical wattmeter OPM-1D

XII

### Middle layer:

6. FO crimp tool GI20 99 000 1031
7. Combi-shears (all-purpose shears)
8. Microstrip FO
9. Stripping tool
10. Kevlar shears
11. Universal cutter with plastic handle
12. Light source 850 nm
13. Fibre checker
14. Fibre cleaving tool
15. Hinged box
  - a. F-ST adapter for OPM
  - b. F-LC adapter for OPM
  - c. Heating box adapter F-ST .....20 99 002 1082
  - d. Heating box adapter F-SC / DIN 41626 .....20 99 003 1082
  - e. Heating box adapter F-LC .....20 99 004 1082
  - f. Polish tool DIN 41626 .....20 99 000 1092
  - g. Polish tool F-ST.....20 99 000 1095
  - h. Polish tool F-SC .....20 99 000 1097
  - i. Polish tool F-LC .....20 99 000 1090
  - j. Epo-Tek 360 (4g) .....20 80 001 9902
  - k. F-ST coupling.....20 80 000 1021
  - l. F-LC coupling
  - m. F-SC coupling
  - n. Disposable syringe 2 ml
  - o. Cannula for disposable syringe
  - p. Precision stripper 0.4 HCS
  - q. Adapter 1.25 mm for fibre checker

## Upper tray:

16. Grinding surface made of rubber
17. Polishing foils 1  $\mu\text{m}$  (5 sheets) .....20 80 001 9913
18. Polishing foils 9  $\mu\text{m}$  (5 sheets) .....20 80 001 9912
19. One click cleaner 1.25 mm .....20 80 001 9920
20. One click cleaner 2.5 mm .....20 80 001 9921
21. Documentation
22. Adapter cable GI 50/125 F-LC/F-ST
23. Adapter cable GI 50/125 F-LC/DIN 41626 male
24. Adapter cable GI 50/125 F-LC/DIN 41626 female
25. Adapter cable GI 50/125 F-LC/F-SC
26. Adapter cable GI 50/125 F-LC/F-LC

The assembly and operating instructions on the following tools are included.

## 7. Overview of assembly

Table XII-2: Overview of assembly

Part number	Description	Tools required for assembling HARTING FO standard contacts/connectors					
		Fibre stripper	FO crimp tool <sup>1)</sup>	Four-indent crimping tool	Polish tool	Adhesive	Grinding and polishing paper
20 10 001 1211	F-SMA connector, 1 mm/2.2 mm POF with hexagon nut	20 99 000 1045	20 99 000 1033	20 99 000 1035			20 80 001 9911
20 10 001 1212	F-SMA-Quick assembly connector 1 mm/2.2 mm POF with hexagon nut	20 99 000 1045			20 99 000 1091		20 80 001 9911
20 10 001 1213	F-SMA connector 1 mm/2.2 mm POF with knurled nut	20 99 000 1045	20 99 000 1033	20 99 000 1035	20 99 000 1091		20 80 001 9911
20 10 001 1215	F-SMA quick assembly connector 1 mm/2.2 mm POF with knurled nut	20 99 000 1045			20 99 000 1091		20 80 001 9911
20 10 001 1217	F-SMA quick assembly connector 1 mm/2.2 mm POF with knurled nut and bend protection	20 99 000 1045			20 99 000 1091		20 80 001 9911
20 10 001 1221	F-SMA connector POF/SERCOS 6.0 with hex nut	20 99 000 1045	20 99 000 1033	20 99 000 1035	20 99 000 1091		20 80 001 9911
20 10 001 1223	F-SMA connector POF/SERCOS 6.0 with knurled nut	20 99 000 1045	20 99 000 1033	20 99 000 1035	20 99 000 1091		20 80 001 9911

<sup>1)</sup> for fibre optics = 20 99 000 1033/for POF = 20 99 000 1031

Table XII-2: Overview of assembly (continuation)

Part number	Description	Tools required for assembling HARTING FO standard contacts/connectors						
		Fibre stripper	FO crimp tool <sup>1)</sup>	Four-indent crimping tool	Polish tool	Adhesive	Grinding and polishing paper	
20 10 001 1241	F-SMA connector POF/SERCOS 3.6 with hex nut	20 99 000 1045	20 99 000 1033	20 99 000 1035	20 99 000 1091		20 80 001 9911	
20 10 001 1243	F-SMA connector POF/SERCOS 3.6 with knurled nut	20 99 000 1045	20 99 000 1033	20 99 000 1035	20 99 000 1091		20 80 001 9911	
20 10 001 2211	FH-ST connector 1 mm/2.2 mm POF	20 99 000 1045	20 99 000 1033	20 99 000 1035	10 99 000 1095		20 80 001 9911	
20 10 001 2212	FH-ST quick assembly connector 1 mm/2.2 mm POF	20 99 000 1045			20 99 000 1065		20 80 001 9911	
20 10 001 3211	FO male insert 1 mm/2.2 mm POF for Han DD®, Han® K	20 99 000 1045		20 99 000 1035	20 99 000 1093		20 80 001 9911	
20 10 001 3212	FO male insert 1 mm/2.2 mm POF for Han D®, Han® U	20 99 000 1045		20 99 000 1035	20 99 000 1093		20 80 001 9911	
20 10 001 3213	FO male insert 1 mm/2.2 mm POF for Han® 15 D	20 99 000 1045		20 99 000 1035	20 99 000 1093		20 80 001 9911	
20 10 001 3221	FO female insert 1 mm/2.2 mm POF for Han DD®, Han® K	20 99 000 1045		20 99 000 1035		20 80 001 9911		
20 10 001 3222	FO female insert 1 mm/2.2 mm POF for Han D®, Han® U	20 99 000 1045		20 99 000 1035	20 99 000 1093		20 80 001 9911	
20 10 001 3232	FO cable end sleeve 1 mm/2.2 mm POF	20 99 000 1045		20 99 000 1035	20 99 000 1096		20 80 001 9911	

<sup>1)</sup> for fibre optics = 20 99 000 1033/for POF = 20 99 000 1031

Table XII-2: Overview of assembly (continuation)

Part number	Description	Tools required for assembling HARTING FO standard contacts/connectors					
		Fibre stripper	FO crimp tool <sup>1)</sup>	Four-indent crimping tool	Polish tool	Adhesive	Grinding and polishing paper
20 10 001 3311	FO male insert 1 mm/2.2 mm POF for Han E®	20 99 000 1045		20 99 000 1035	20 99 000 1093		20 80 001 9911
20 10 001 3321	FO female insert 1 mm/2.2 mm POF for Han E®	20 99 000 1045		20 99 000 1035	20 99 000 1093		20 80 001 9911
20 10 001 4211	FO male insert Multi Module	20 99 000 1045	20 99 000 1033	20 99 000 1035	20 99 000 1092		20 80 001 9911
20 10 001 4221	FO female insert, 1 mm/2.2 mm POF for Han® Multi Contact Module	20 99 000 1045	20 99 000 1033	20 99 000 1035	20 99 000 1092		20 80 001 9911
20 10 001 6211	F-TNC connector (male) 1 mm/2.2 mm POF	20 99 000 1045			20 99 000 1094		20 80 001 9911
20 10 001 6233	F-TNC built-in socket 1 mm/2.2 mm POF	20 99 000 1045			20 99 000 1094		20 80 001 9911
20 10 001 7111	Versatile link connector 1 mm/2.2 mm POF	20 99 000 1045			20 80 001 9914		
20 10 001 7112	Versatile link connector 1 mm/2.2 mm POF, crimpless	20 99 000 1045			20 80 001 9914		
20 10 125 1212	F-SMA connector 125 GI	20 99 000 1046	20 99 000 1031		20 99 000 1091	20 80 001 9902	20 80 001 9912 20 80 001 9913
20 10 125 2212	FH-ST connector 125 GI	20 99 000 1046	20 99 000 1031		20 99 000 1095	20 80 001 9902	20 80 001 9912 20 80 001 9913
20 10 125 4211	FO male insert (metal) 125 GI for Han® Multi Module	20 99 000 1046			20 99 000 1092	20 80 001 9902	20 80 001 9912 20 80 001 9913

<sup>1)</sup> for fibre optics = 20 99 000 1033/for POF = 20 99 000 1031



Table XII-2: Overview of assembly (continuation)

Part number	Description	Tools required for assembling HARTING FO standard contacts/connectors					
		Fibre stripper	FO crimp tool <sup>1)</sup>	Four-indent crimping tool	Polish tool	Adhesive	Grinding and polishing paper
20 10 125 4212	FO male insert (ceramic) 125 GI for Han® Multi Module	20 99 000 1046			20 99 000 1092	20 80 001 9902	20 80 001 9912 20 80 001 9913
20 10 125 4221	FO female insert (metal) 125 GI for Han® Multi Module	20 99 000 1046			20 99 000 1092	20 80 001 9902	20 80 001 9912 20 80 001 9913
20 10 125 4222	FO female insert, (ceramic) 125 GI for Han® Multi Contact Module	20 99 000 1046			20 99 000 1092	20 80 001 9902	20 80 001 9912 20 80 001 9913
20 10 230 1212	F-SMA connector HCS, crimp	20 99 000 1041	20 99 000 1031		20 99 000 1091		20 80 001 9912 20 80 001 9913
20 10 230 2212	FH-ST connector HCS	20 99 000 1041	20 99 000 1031		20 99 000 1095	20 80 001 9902	20 80 001 9912 20 80 001 9913
20 10 230 4211	FO male insert HCS for Han® Multi Module	20 99 000 1041			20 99 000 1092	20 80 001 9902	20 80 001 9912 20 80 001 9913
20 10 230 4221	FO female insert HCS for Han® Multi Module	20 99 000 1041			20 99 000 1092	20 80 001 9902	20 80 001 9912 20 80 001 9913
20 10 125 8211	LC contact for cable- $\phi$ 3 mm (Multi Mode) in the Han-Modular® LC Module	20 99 000 1046	20 99 000 1031		20 99 000 1090	20 80 001 9902	20 80 001 9912
20 10 125 8220	LC contact for cable- $\phi$ $\leq$ 3 mm (Single Mode) in the Han-Modular® LC Module <sup>1)</sup>	20 99 000 1046	20 99 000 1031		20 99 000 1090	20 80 001 9902	20 80 001 9912

<sup>1)</sup> for fibre optics = 20 99 000 1033/for POF = 20 99 000 1031

Table XII-2: Overview of assembly (continuation)

Part number	Description	Tools required for assembling HARTING FO standard contacts/connectors					Grinding and polishing paper
		Fibre stripper	FO crimp tool <sup>1)</sup>	Four-indent crimping tool	Polish tool	Adhesive	
20 10 125 8212	LC contact for cable- $\phi \leq 2.8$ mm (Multi Mode) in the Han-Modular® LC Module	20 99 000 1046	20 99 000 1031		20 99 000 1090	20 80 001 9902	20 80 001 9912
20 10 125 8221	LC contact for cable- $\phi \leq 2.8$ mm (Single Mode) in the Han-Modular® LC Module	20 99 000 1046	20 99 000 1031		20 99 000 1090	20 80 001 9902	20 80 001 9912
20 10 125 5211	SC Contact for GI fibre 50/125 $\mu\text{m}$ or 62.5/125 $\mu\text{m}$ (ceramic ferrule) in Han-Modular® SC Module	20 99 000 1046	20 99 000 1031		20 99 000 1090	20 80 001 9902	20 80 001 9912
20 10 230 5211	SC contact for GI fibre (HCS <sup>®</sup> ) 200/230 $\mu\text{m}$ in Han-Modular® SC Module <sup>1)</sup>	20 99 000 1041	20 99 000 1033		20 99 000 1097		20 80 001 9911
20 10 001 5211	SC contact in crimping technology for 1 mm POF in the Han-Modular® SC Module	20 99 000 1045	20 99 000 1033		20 99 000 1097		20 80 001 9911
20 10 001 5217	SC contact in rapid termination technique for 1 mm POF in the Han-Modular® SC Module	20 99 000 1045	20 99 000 1033		20 99 000 1097		20 80 001 9911

<sup>1)</sup> for fibre optics = 20 99 000 1033/for POF = 20 99 000 1031

## XIII. Attachment

### Table of Contents

1. Glossary.....	250
2. Overview of standards .....	252

## 1. Glossary

XIII

Terms	Explanation
Stripping length	Length of the stripped strand or wire end
Wire ferrule	Sleeve for crimping for finely stranded wires
Tightening torque	Force with which a screw has to be tightened in order to achieve a proper connection
Pull-out force	Force necessary to pull a connected wire from the termination point
Refractive index	Physical units in optics. It describes the refraction of an electromagnetic wave at the transition between two media. The refractive index is calculated as follows: $n = c_0 / c$ $c_0$ = Phase velocity of light in a vacuum $c$ = Phase velocity in the medium
Dispenser	Device for filling the solder pads of a printed circuit board with solder paste
Tightening torque	See Tightening torque
Contact resistance	The electrical resistance in a plugged-in or switched contact pair, measured between the terminal points under specified measuring conditions.
Mono-mode fibre	Also called single-mode fibre. The light propagates in a single guided waveguide mode. Application for large transmission distances and/or bandwidths. Core diameter typically 3 – 9 $\mu\text{m}$ .
Fluxer	A device for applying the flux
Sealed termination point	The termination point has been connected so that air or gas mixtures from the outside have no influence.
Hinged frame	2-piece mounting frame for holding modules from the Han-Modular® series
Graded index fibre	Multimode fibre with a parabolic refractive index of the core. This compensates for a delay difference between the fibre modes (modal dispersion).

Terms	Explanation
HCS	Hard clad silicon. Plastic optical fibres where the optical core are made of quartz glass and the optical jacket are made of a special patented plastic layer. Optical core and optical jacket form an inseparable unit.
Cross-section	Cross section of a wire measured in mm <sup>2</sup>
Stranded wire	Wire is composed of individual wires to achieve flexibility
Lustre terminal	Used for connecting two or more electrical cables
PE panels (or earth panel)	Component for connecting the PE wire and to establish the PE connection to the housing
<i>POF</i>	Plastic Optical Fibre Plastic optical fibres with typically 1mm core diameter. Easily field wireable.
RoHS	Restriction of the Use of Certain Hazardous Substances // Directive 2002/95/EC
Micrograph	Is taken to draw conclusions about specific characteristics of a product. The product is cut open and then sealed in.
SMD	Surface Mounted Device
Current-carrying capacity	The current-carrying capacity is limited by the maximum temperature of the material of the contact insert and contacts including terminations.
Step index fibre	Multimode fibre with stepped refractive index profile. Refractive index is constant at the core and higher than the jacket. Delay differences occur between the fibre modes.
THR	Through Hole Technology

## 2. Overview of standards

### Abbreviations

XIII

DIN	German Institute for Standardisation (German equivalent of ANSI).
EN	European standard
IEC	International Electrotechnical Commission
VDE	Association of German Electricians
ISO	International Organization for Standardization The ISO creates ISO standards that member countries are supposed to adopt without changes.
DIN EN	European standard (EN).
DIN IEC	International standard, adopted as a German standard without changes.
DIN VDE	DIN standard that is also a VDE regulation.
CECC	Cenelec Electronic Components Committee
IPC	Association Connecting Electronic Industries

#### Cenelec

CECC 75 301-801	Design specification for multiple-pole, rectangular connectors with round, replaceable crimp contacts
-----------------	---

<b>DIN</b>	
DIN 41 611-4	Solderless electrical connections; clip connections; terminology, requirements, testing
DIN 41 603-1	Connectors for frequencies for use with printed circuit boards: Generic specification: General requirements and guide for the preparation of detail specifications, with assessed quality
DIN 41 652	Rack and panel connectors, trapezoidal, round contacts Ø 1 mm
DIN 46 230	Cable shoes for solderless connections; pin type, without insulating sleeve, for copper wires
DIN 46 330	Short Faston sleeves without insulating sleeve for 2.4 width connector
DIN ISO 857-2-03	Welding and related processes: terms Part 2: Soft and hard soldering and related terms
<b>DIN EN</b>	
DIN EN 175 301-801	Design specification: multiple-pole, rectangular connectors with round, replaceable crimp contacts
DIN EN 50 173	Information technology - Generic cabling systems
DIN EN 60 204-1	Safety of machinery - Electrical equipment of machines - Part 1: General
DIN EN 60 352-1	Solderless connections - Part 1: Wrapped connections; general requirements, test methods and usage notes
DIN EN 60 352-2	Solder-free connections - Part 2: Crimp connections; general requirements, testing methods and usage notes
DIN EN 60 352-3	Solder-free electrical connections - Part 3: general requirements, testing methods and usage notes
DIN EN 60 352-4	Solder-free electrical connections - Part 4: general requirements, testing methods and usage notes

<b>DIN EN</b>	
DIN EN 60 352-5	Solder-free electrical connections – Part 5: press-in connections - general requirements, testing methods and usage notes
DIN EN 60 352-7	Solder-free electrical connections – Part 7: spring clamp connections general requirements, testing methods and usage notes
DIN EN 60 603-13	Connectors for frequencies below 3 MHz for use with printed boards - Part 13: Detail specification for two-part connectors of assessed quality, for printed boards for basic grid of 2.54 mm (0.1 in), with free connectors for non-accessible insulation displacement terminations (ID)
DIN EN 60 603-7	Connectors for electronic equipment - Part 7: Detail specification for unshielded, free and fixed connectors, 8 poles (IEC 48B / 1746 / CDV:2007)
DIN EN 60 999-1	Connecting material - Electrical copper wires; Safety requirements for screw-type and screwless termination points - Part 1: General requirements and particular requirements for termination points for wires 0.2 mm <sup>2</sup> to 35 mm <sup>2</sup>
DIN EN 60 999-2	Connecting material - Electrical copper wires; Safety requirements for screw-type and no-screw termination points - Part 2: General requirements and particular requirements for termination points for wires 35 mm <sup>2</sup> to 300 mm <sup>2</sup>
DIN EN 61 984	Connectors – Safety requirements and tests
<b>DIN VDE</b>	
DIN VDE 0100-410	Low-voltage electrical installations - Parts 4-4-1: Protection measures - Protection against electric shock



<b>IEC</b>	
IEC 60 603-2	Connectors for frequencies below 3 MHz for use with printed boards - Part 2: Detail specification for two-part connectors of assessed quality, for printed boards for pitch of 2.54 mm (0.1 in), with common mounting features
IEC 60807	Rectangular connectors for frequencies below 3 MHz; Part 1: Generic specification; general requirements
IEC 61 076-4-107	Connectors for electronic equipment - Parts 4-107: Printed board connectors with assessed quality; Detail specification for shielded indirect connectors having a pitch of 2.0 mm, free part with solder and press-in terminations for printed boards, fixed part with non-accessible insulation displacement and crimp terminations
ISO/IEC 11 801	Information technology – Generic cabling for customer premises
<b>IPC</b>	
IPC-A-6 10D	Acceptability of Electronic Assemblies
IPC/JEDEC J-STD-020E	Moisture/Reflow Sensitivity Classification for non hermetic solid state surface mount devices
IPC/JEDEC J-STD-033C	Standard for Handling, Packing, Shipping and Use of Moisture Reflow, Sensitive SMDs
<b>VDE</b>	
VDE 0100-520	Low-voltage electrical installations - Part 5: Selection and setting up of electrical equipment - Chapter 52: Wiring systems
VDE 0295/ DIN EN 60 228	Conductors of insulated cables
VDE 0627/ DIN EN 62 984	Connectors – Safety requirements and tests



## Notes

XIII

A large rectangular area filled with alternating horizontal bands of light yellow and light gray, intended for taking notes.



**Pushing Performance**

[www.HARTING.com](http://www.HARTING.com)



Pushing Performance

**HARTING.com** –  
the gateway to your  
country website.

---

[www.HARTING.ae](http://www.HARTING.ae)  
[www.HARTING.at](http://www.HARTING.at)  
[www.HARTING.com.au](http://www.HARTING.com.au)  
[www.HARTING.be](http://www.HARTING.be)  
[www.HARTING.com.br](http://www.HARTING.com.br)  
[www.HARTING.ca](http://www.HARTING.ca)  
[www.HARTING.ch](http://www.HARTING.ch)  
[www.HARTING.com.cn](http://www.HARTING.com.cn)  
[www.HARTING.cz](http://www.HARTING.cz)  
[www.HARTING.de](http://www.HARTING.de)  
[www.HARTING.dk](http://www.HARTING.dk)  
[www.HARTING.es](http://www.HARTING.es)  
[www.HARTING-easterneurope.com](http://www.HARTING-easterneurope.com)  
[www.HARTING.fi](http://www.HARTING.fi)  
[www.HARTING.fr](http://www.HARTING.fr)  
[www.HARTING.co.uk](http://www.HARTING.co.uk)  
[www.HARTING.com.hk](http://www.HARTING.com.hk)  
[www.HARTING.hu](http://www.HARTING.hu)  
[www.HARTING.co.in](http://www.HARTING.co.in)  
[www.HARTING.it](http://www.HARTING.it)  
[www.HARTING.co.jp](http://www.HARTING.co.jp)  
[www.HARTING.co.kr](http://www.HARTING.co.kr)  
[www.HARTINGbv.nl](http://www.HARTINGbv.nl)  
[www.HARTING.no](http://www.HARTING.no)  
[www.HARTING.pl](http://www.HARTING.pl)  
[www.HARTING.pt](http://www.HARTING.pt)  
[www.HARTING.ro](http://www.HARTING.ro)  
[www.HARTING.ru](http://www.HARTING.ru)  
[www.HARTING.se](http://www.HARTING.se)  
[www.HARTING.sg](http://www.HARTING.sg)  
[www.HARTING.sk](http://www.HARTING.sk)  
[www.HARTING.com.tr](http://www.HARTING.com.tr)  
[www.HARTING.com.tw](http://www.HARTING.com.tw)  
[www.HARTING-USA.com](http://www.HARTING-USA.com)  
[www.HARTING.co.za](http://www.HARTING.co.za)

**HARTING Technology Group**

[de@HARTING.com](mailto:de@HARTING.com)  
[www.HARTING.de](http://www.HARTING.de)

[at@HARTING.com](mailto:at@HARTING.com)  
[www.HARTING.at](http://www.HARTING.at)

[ch@HARTING.com](mailto:ch@HARTING.com)  
[www.HARTING.ch](http://www.HARTING.ch)

BD / 2016-04-05 / 1.0 98 48 916 0201